

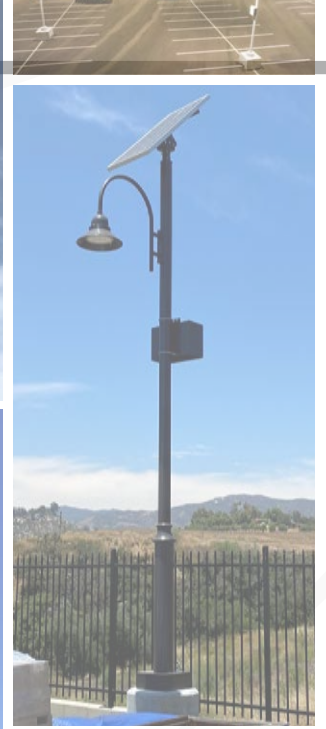

 Greenshine

OUTDOOR SOLAR LIGHTING SOLUTIONS



LUMINA

# LUMINA | GENERAL SPECIFICATIONS



Greenshine

## Light Fixture (GS-LED-L30)

Luminaire Input Voltage	DC 12V   24V
Power Consumption	30W   40W   60W   80W
Lumen	3291   4640   6187   7865 lumens
Color Temperature	3000-4000 K
IES Lighting Type	Type II   V
Material	Die-cast aluminum



## Solar Panel (1 or 2 Units)

### 110W

### 180W

Rating Power	110 W	180 W
Maximum Power Voltage	17.60 V	18.95 V
Maximum Power Current	6.25 A	9.50 A
Open Circuit Voltage	21.7 V	22.74 V
Short Circuit Current	6.71	9.98 A
Size	47.5" x 27"	58.5" x 27"
Weight	23.4 lb	29.5 lb

## Battery (1 or 2 Units)

Battery Type	GEL Deep Cycle Lead-Acid
Operating Voltage	12 V
Capacity	150 Ah at 20 hr-rate to 1.75 V per cell at 77°F
Dimensions	16(L)×7(W)×9.2(H) (in)
Expected Life	5 ~ 7 years

## Solar Charger

Operating Voltage	12 V/24 V auto recognition
Max. Charge / Load Current	5 A/ 10 A/ 20 A (different models)
Night / Day Detection	2.5 V – 10 V
IP Class	IP68

## Pole

Height	20 ft
Diameter	6 3/4" at the bottom, 4" at the top
Thickness	5/32"
Material	Galvanized Steel
Finishing	Powder Coating



# LUMINA | GENERAL SPECIFICATIONS



Greenshine

## SPECIFICATIONS

Luminaire Input Voltage  
Power Consumption  
Lumen Output  
Color Temperature  
IES Lighting Type  
Material  
Lens  
IP Class  
Insulation  
Operating Temperature  
CRI

DC 12V | 24V  
30W | 40W | 60W | 80W  
3291 | 4640 | 6187 | 7865 lumens  
3000-4000 K  
Type II | III | V  
High pressure die-cast aluminum  
5mm toughened glass, optical grade PMMA  
IP 65  
Class I  
-30°C ~+50°C / -22°F ~+122°F  
≥70

**Weight:** 8.3 kg | 18.3 lb

## DIMENSIONS

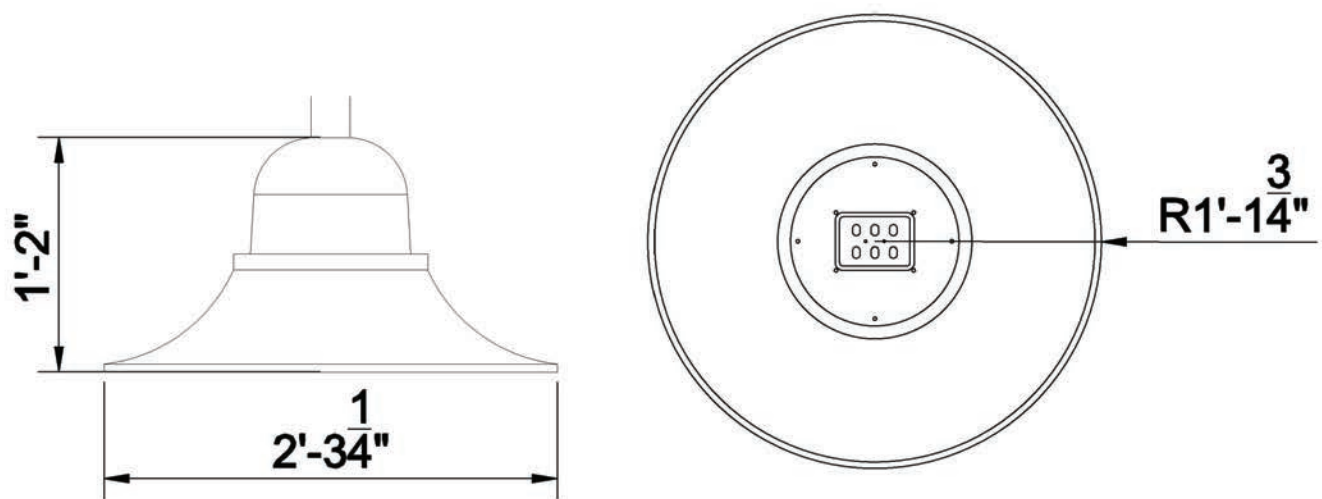



# LUMINA SERIES

## Solar Powered LED Lighting System

Greenshine

### OVERVIEW

The Lumina Series features customizable outdoor solar light solutions depending on your specific application and an adjustable mounting bracket. Each system is completely customized according to your location, project and lighting requirements; also systems can be configured to run throughout the night or have them dim to save energy when full light is not required and with the option for a motion detection.

### PART NUMBER

SYSTEM	LUM. QTY.	LUMINAIRE	OPTICS	LOAD	COLOR TEMP.	DRIVER	ARM	BOX QTY.
<b>LU</b> Lumina	<b>1</b> Single <b>2</b> Dual	<b>L30</b> Lumina	<b>T2</b> Type 2 <b>T3</b> Type 3 <b>T5</b> Type 5	<b>30W</b> <b>40W</b> <b>60W</b> <b>80W</b> <b>##</b>	<b>3K</b> 3000 Kelvin <b>4K</b> 4000 Kelvin <b>5K</b> 5000 Kelvin	<b>350MA</b> <b>525MA</b> <b>700MA</b> <b>950MA</b>	<b>SH</b> Shepherd's Hook	<b>1</b> 1 Box <b>2</b> 2 Boxes
BATTERY QTY.	BATT. MNT.	BATTERY	PV QTY.	PV WATT	POLE HEIGHT	COLOR	OPERATING PROFILE	
<b>1B</b> 1 Battery <b>2B</b> 2 Batteries <b>3B</b> 3 Batteries <b>4B</b> 4 Batteries	<b>H</b> High <b>L</b> Low	<b>120</b> 120 amp <b>150</b> 150 amp <b>200</b> 200 amp	<b>1</b> Single <b>2</b> Dual <b>4</b> Quad* <small>*Requires smooth straight tapered pole*</small>	<b>110W</b> <b>180W</b>	<b>P20</b> 20ft <b>P26</b> 26ft <b>P#</b> Custom	<b>BK</b> Black <b>BZ</b> Bronze <b>C#</b> Custom	<b>5/40 DIM</b> <b>6/40 DIM</b> <b>7/40 DIM</b> <b>8/40 DIM</b> <b>D2D</b>	

### FIXTURES

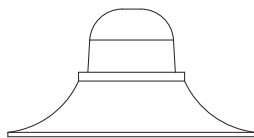

**LUMINA**  
30W-40W-60W-80W  
TYPE 2, 3 & 5

Decorative Luminaire Series available. See Decorative Data-sheets for more info.

### SPECIFICATIONS

- ▶ **Luminaire**
  - 60,000 hours.
  - 3000K - 5000K available with standard 4000K.
  - Turtle Friendly compliant fixtures available.
- ▶ **Panel Mount**
  - Rated to 145mph. 185mph available.
- ▶ **Solar Panel**
  - Mono-crystalline Photovoltaic solar panels.
- ▶ **Battery Enclosure**
  - Vented, corrosion resistant stainless steel battery box.
  - Holds battery and controller.
  - Includes lock.
- ▶ **GEL-Type Battery**
  - Greenshine Battery - Maintenance-free 99% recyclable.
  - 120Ah - 200Ah seal GEL Cell batteries.
- ▶ **Smart Controller**
  - Controller - Solar Charge controller that monitors and regulates charging and discharging of batteries. Also, programable to specific operating profile for project.
- ▶ **5 Year Limited Warranty**
  - Includes 10 year warranty on solar panel. 5 and 10 Year Full Warranty available.

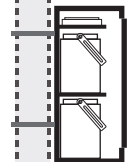
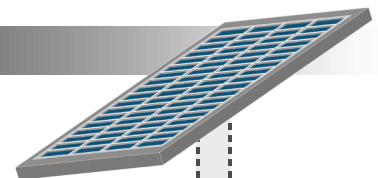



# GREENSHINE SOLAR PANEL

Solar Powered LED Lighting System



Greenshine

## OVERVIEW

- Mono-Crystalline solar cells
- Aluminum frame with a unique design to withstand strong winds
- Highly resistant tempered glass
- Multilayer EVA encapsulation with triple layer back sheet
- 25-year power output warranty: 5 years/95%, 12 years/90%, 25 years/80%.

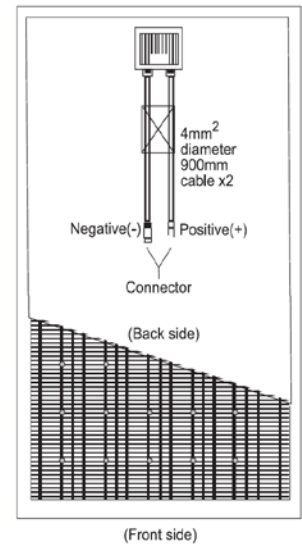

## Rating Power

110W

180W

Product Tolerance	± 3%	± 3%
Maximum Power Voltage	17.60V	18.95V
Maximum Power Current	6.25A	9.50A
Open Circuit Voltage	21.7 V	22.74 V
Short Circuit Current	6.71 A	9.98 A
Frame	Anodized aluminum, 4mm thickness	
Dimensions	1208mm x 682mm 47.5" x 27" 10.6kg   23.4lb	1486mm x 682mm 58.5" x 27" 13kg   29.5lb
Test Temperature	25°C   77°F, 1000w/m², Air Mass 1.5	
Junction Box / Wiring	IP65 Junction box with 900mm cable with MC4 connectors	



# LUMINA SERIES

## Solar Powered LED Lighting System



### TECHNICAL

Description	Mount Dimensions (L x W)	Solar Panel	PV Dimensions (L x W)	EPA @ 45° Power Unit	System Weight	Pole Tenon
SINGLE	1208mm x 682mm 47.5" x 27"	110W	1208mm x 682mm 47.5" x 27"	0.8 sq meter	25kg 55lb	3" O.D 76mm O.D
	1486mm x 682mm 58.5" x 27"	180W	1486mm x 682mm 58.5" x 27"	1 sq meter	38kg 83lb	3" O.D 76mm O.D
DUAL	1208mm x 1400mm 47.5" x 55"	110W	1208mm x 682mm 47.5" x 27"	1.6 sq meter	27kg 60lb	3" O.D 76mm O.D
	1486mm x 1400mm 58.5" x 55"	180W	1486mm x 682mm 58.5" x 27"	2 sq meter	43kg 94lb	3" O.D 76mm O.D
QUAD	1208mm x 3000mm 47.5" x 118"	110W	1208mm x 682mm 47.5" x 27"	3.2 sq meter	54kg 120lb	3" O.D 76mm O.D
	1486mm x 3000mm 58.5" x 118"	180W	1486mm x 682mm 58.5" x 27"	4 sq meter	86kg 188lb	3" O.D 76mm O.D

### MOUNTS

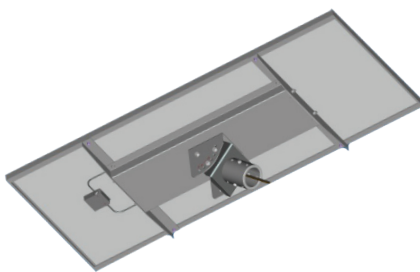

SINGLE MOUNT

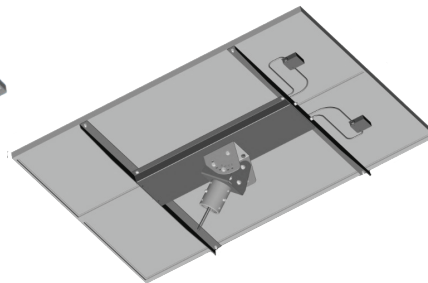

DUAL MOUNT

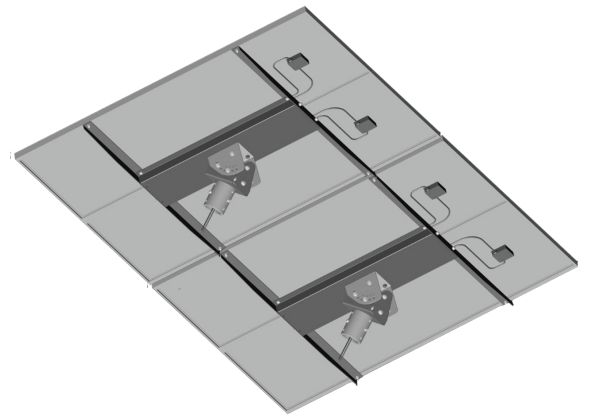

QUAD MOUNT

### ARMS

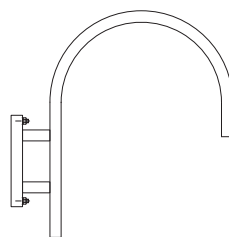

Shepherd's Hook

# GREENSHINE GEL-TYPE BATTERY

Solar Powered LED Lighting System



Greenshine

## OVERVIEW

GEL deep cycle battery with a 12 years floating design life is especially designed for frequent cyclic discharge under extreme temperature.



	GS-GEL-H120	GS-GEL-H150	GS-GEL-H200
Cells per unit	6	6	6
Voltage per unit	12V	12V	12V
Capacity	120Ah @ 20hr-rate to 1.75V per cell @ 25°C / 77°F	150Ah @ 20hr-rate to 1.75V per cell @ 25°C / 77°F	200Ah @ 20hr-rate to 1.75V per cell @ 25°C / 77°F
Weight	38kg / 84lb	46kg / 100lb	59.2kg / 131.5lb
Dimensions L x W x H	406 x 173 x 233(mm) 16" x 7" x 9.2"	483 x 170 x 240(mm) 19" x 6.7" x 9.5"	522 x 240 x 218(mm) 20.5" x 9.44" x 8.7"
Max Discharge Current	1200A (5 Sec)	1500A (5 Sec)	2000A (5 Sec) <sup>2</sup>
Operating Temp. range	-40°C~60°C   -40°F~140°F		
Flot Charging Voltage	13.6 to 13.8 VDC / unit average at 25°C / 77°F		
Recommended max. charging current	24A	30A	40A
Self-discharge	Valve Regulated Lead Acid can be stored for more than 6 months at 25°C/77°F. Self-discharge ratio less than 3% per month at 25°C/77°F. Please charge batteries before using.		
Equalization and cycle service	14.6 to 14.8 VDC / unit average at 25°C / 77°F		
Terminal type	5ft cooper wire leads from the battery case		



## BATTERY ENCLOSURE

### OVERVIEW

- Housing - Made of 201 stainless steel with powder coating finish unit that holds battery and smart controller. Vented to allow air circulation around batteries. Easy access through hinged/removable front cover to allow quick servicing or battery replacement. Maintenance-free 99% recyclable.
- Mounting - Mounted to Pole at low, mid or high placements.
- Battery - Our battery enclosures are designed to fit our 80Ah, 120Ah, 150Ah and 200Ah GEL TYPE batteries.
- Five Year System Warranty - Includes five year limited warranty on batteries.
- Controller - Mounted inside of hinged battery enclosure for ease of maintenance.
- The Battery Box is a stainless steel enclosure that has a lock for additional security.

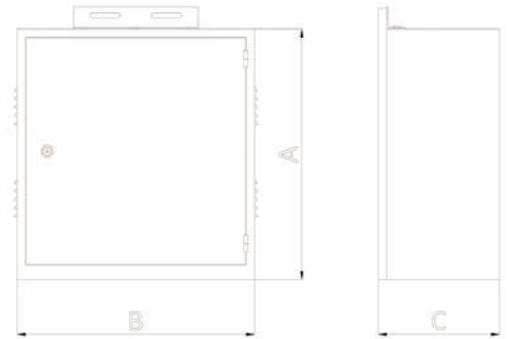
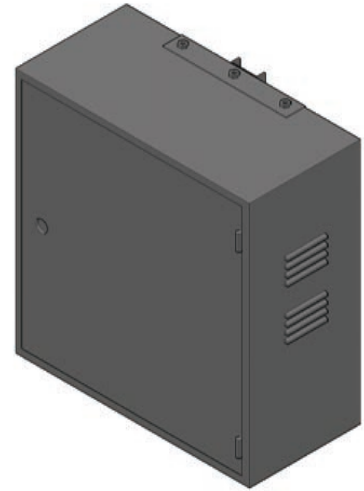

TYPE	# OF BATTERIES	DIMENSIONS: L x W x D (A x B x C)	WEIGHT	EFFECTIVE PROJECTED AREA (EPA)
1150	1 X 150AH	15.75"x22.4"x10.6" (inch) 40x57x27 (cm)	30 lb 13.6 kg	3.43 sq ft 0.319 m2
1200	1 X 200AH	15.75"x23.6"x12.2" (inch) 40x60x31 (cm)	35 lb 15.8 kg	3.61 sq ft 0.336 m2
2150	2 X 150AH	23.5"x22.4"x10.6" (inch) 60x57x27 (cm)	40 lb 18.1 kg	5.11 sq ft 0.476 m2
2200	2 X 200AH	24.4"x23.6"x12.6" (inch) 62x60x32 (cm)	45 lb 20.4 kg	5.58 sq ft 0.518 m2

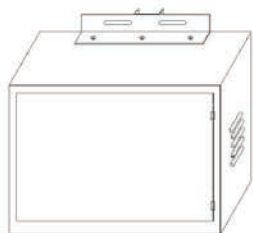

1 X 150AH

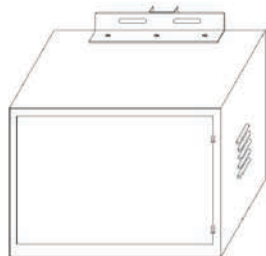

1 X 200AH

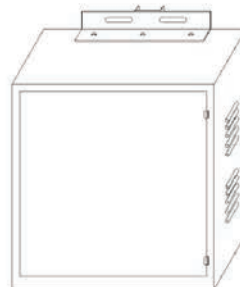

2 X 150AH

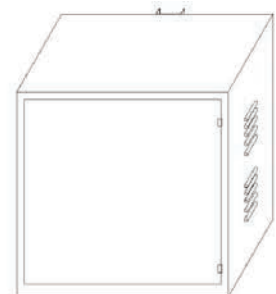

2 X 200AH

# GREENSHINE CONTROLLER

## Solar Powered LED Lighting System



Greenshine

### FEATURES

- Corrosion-proof epoxy-encapsulated PCB (IP68)
- Four-stage battery charging (main, float, boost, equalization)
- Temperature compensated
- Automatic system voltage recognition (12V/24V)
- Customized by Greenshine to fit specific needs of clients
- Easy to install

### SPECIFICATIONS

System Voltage

12V | 24 Auto Recognition

Max. charge / load current

5A | 10A | 20A (Different Models)

#### Deep discharge protection:

Cut-off Voltage

11V - 12V | 22V - 24V

Reconnect Level

12.8V | 25.6V

Overvoltage Protection

15.5V | 31.0V

Undervoltage Protection

10.5V | 21V

Max. Panel Voltage

$U_{BATmin} + 30V$  (if module and battery are connected with correct polarity)

Temperature compensation

-25mV | K at 12V

(Charge Voltage)

-50mV | K at 24V

Ambient Temperature

-40°C to +60°C, -40°F to +140°F

Max. Altitude

4,000m above sea level

Battery Type

Lead acid (GEL, AGM, flooded)

#### Adjustment Range:

Evening / Morning Hours

0 - 15h | 0 - 14h

Night / Day Detection

2.5V - 10V

Wire Cross Section

1.5mm<sup>2</sup>/ 1.5mm<sup>2</sup>/ 2.5mm<sup>2</sup>, 15 (AWG)

Type of Protection

IP68 (1.5 m, 72 h)





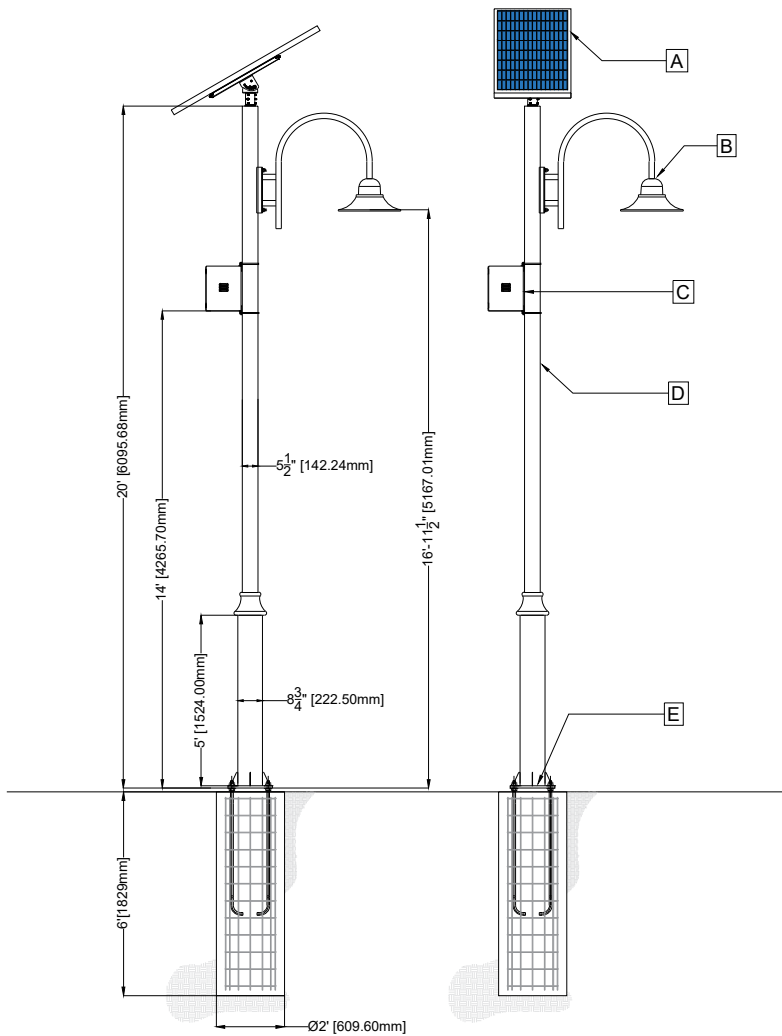

- LEGEND**
- A. Mono-Crystalline Solar Cell - Solar Panel; Orient towards True South per manufacturer's recommendation.
  - B. Luminaire
  - C. Battery Box
  - D. 6 3/4" at the bottom, 4" at the top - Tapered Galvanized Steel Pole
  - E. Flange

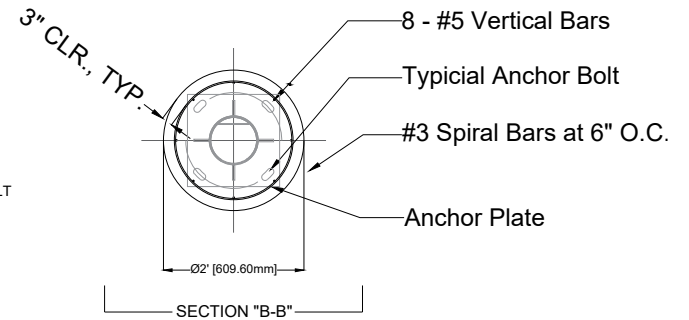
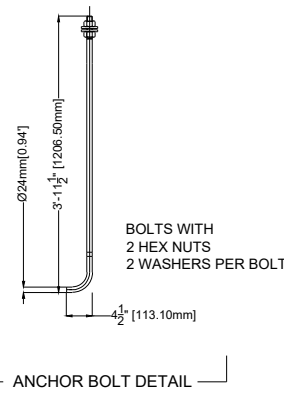
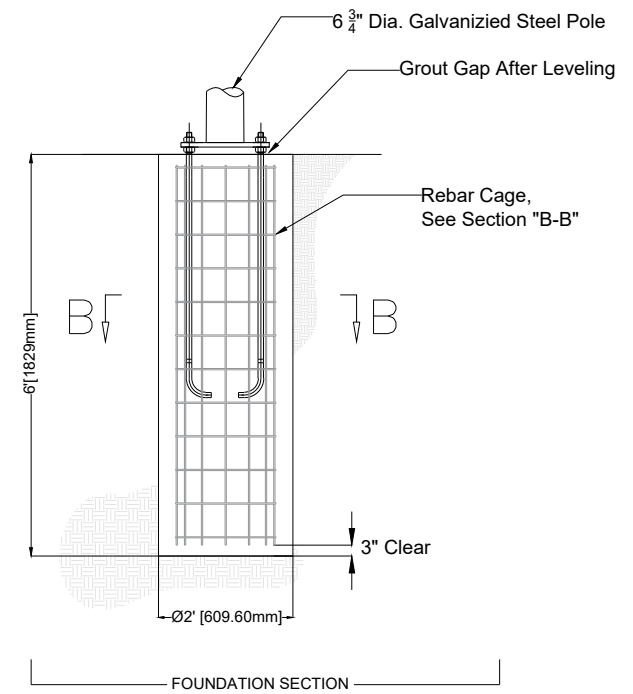

**SECTION "A-A"**

Flange Detail

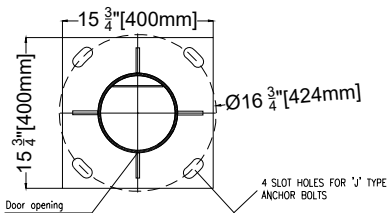

- Foundation dimensions shall be confirmed by a local engineering company, Greenshine New energy will not be held liable for any defect of the concrete foundation due to improper sizing.  
 - Drawings are based using hot-dipped galvanized steel, powder coating with a thickness of 0.032"  
 - \*EPA of the system exclude the EPA of the pole, includes the solar panels, brackets, arm and LED fixture and battery box.  
 - \*\*Wind resistance of the poles are indicative and further customization can be provided.

Tilt angle of the solar panels	15	30	45	60
EPA (ft <sup>2</sup> )*	3.94	7.58	10.76	13.13
Wind resistance** (mph)	150	150	150	150

System	Lumina - 20' - 1P
By	Luis Jimenez
Date	4/23/2021
Website	www.streetlights-solar.com



Greenshine

**Project 1**



03 / 23 / 2020

Greenshine New Energy

23661 Birtcher Dr  
Lake Forest, CA 92630

Operator Luis Jimenez  
Telephone 949-609-9636 X 104  
Fax  
e-Mail [luis.jimenez@streetlights-solar.com](mailto:luis.jimenez@streetlights-solar.com)

**LUMINA 30W - 20' POLE / 3D Rendering**

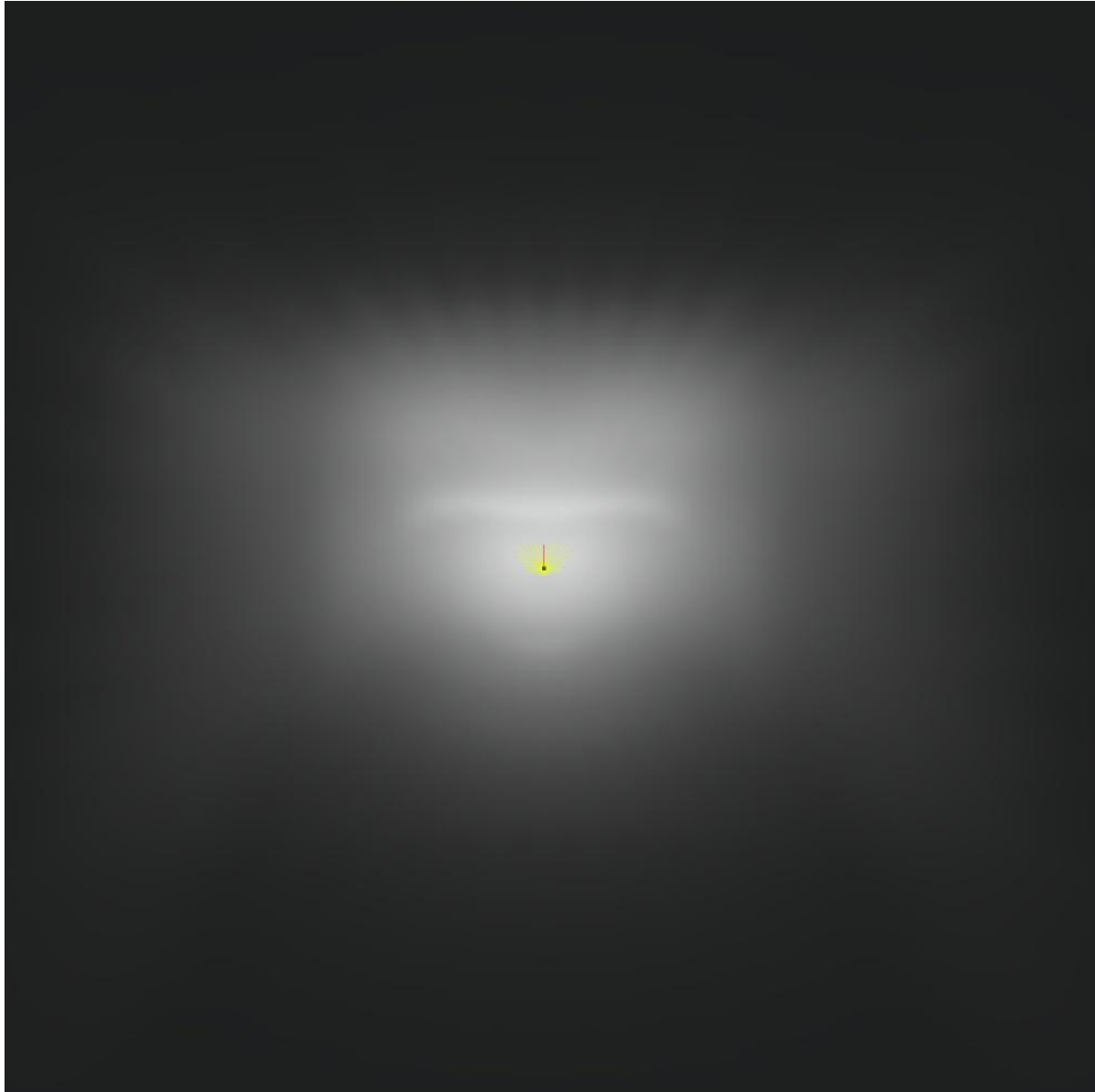



Greenshine New Energy  
23661 Birtcher Dr  
Lake Forest, CA 92630

Operator Luis Jimenez  
Telephone 949-609-9636 X 104  
Fax  
e-Mail luis.jimenez@streetlights-solar.com

### LUMINA 30W - 20' POLE / False Color Rendering

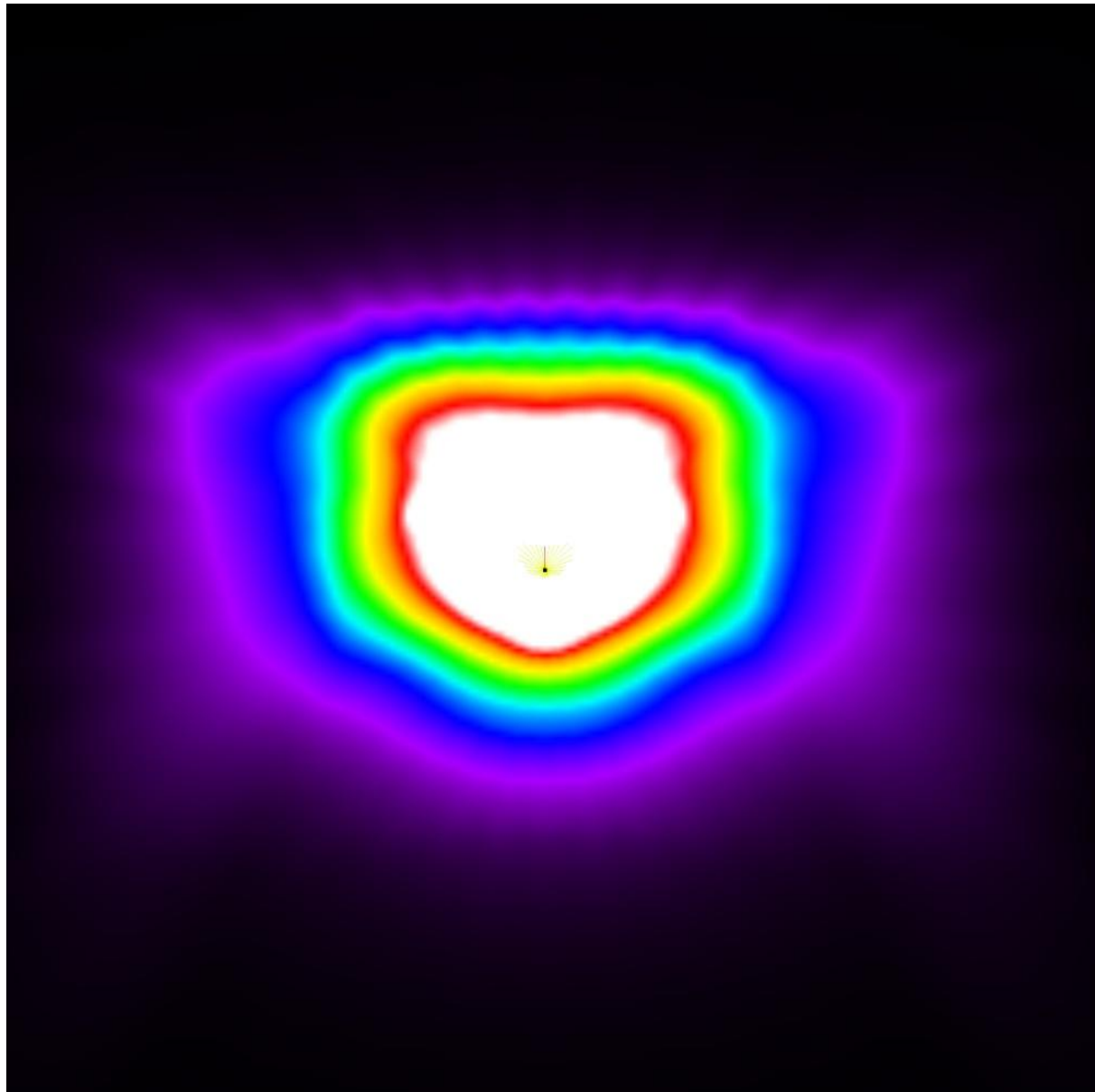

0 0.13 0.25 0.38 0.50 0.63 0.75 0.88 1.00 fc

Greenshine New Energy  
 23661 Birtcher Dr  
 Lake Forest, CA 92630

Operator Luis Jimenez  
 Telephone 949-609-9636 X 104  
 Fax  
 e-Mail luis.jimenez@streetlights-solar.com

### LUMINA 30W - 20' POLE / Calculation Grid 1 / Isolines (E, Perpendicular)

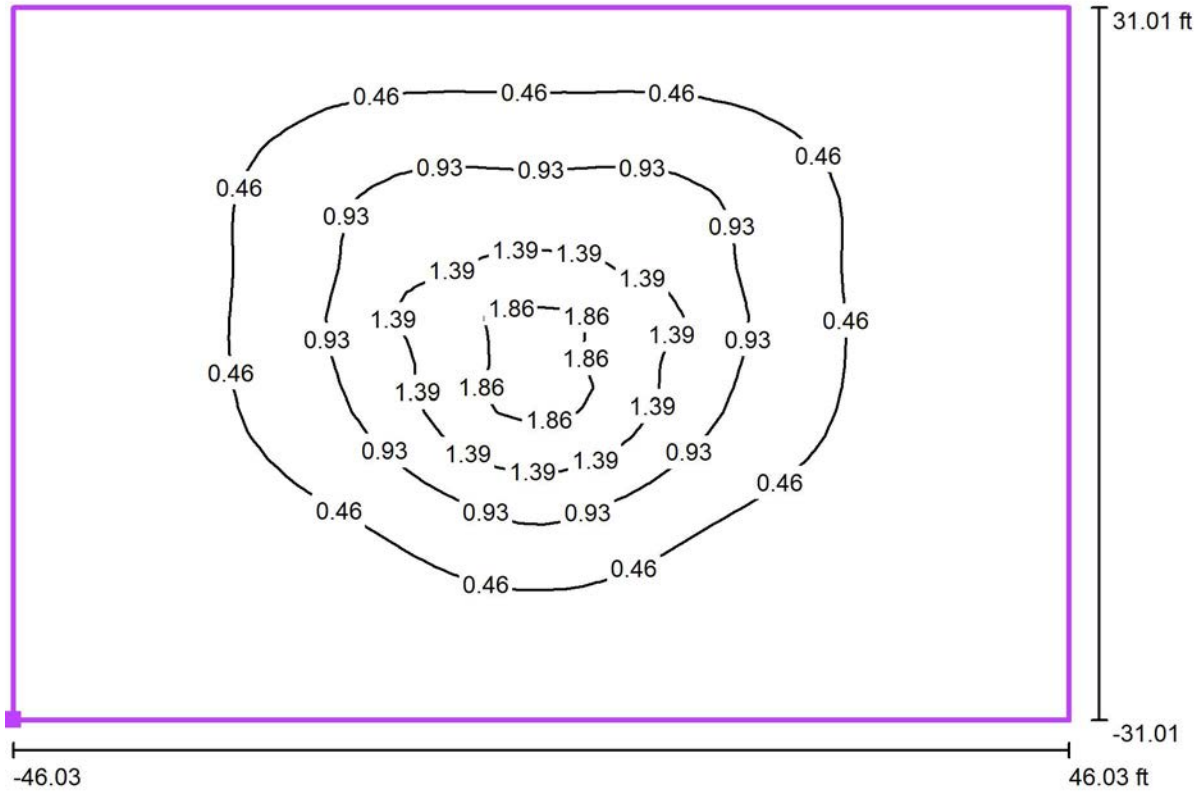

Values in Footcandles, Scale 1 : 201

Position of surface in external scene:  
 Marked point: (126.012 ft, 144.319 ft,  
 0.000 ft)



Grid: 50 x 30 Points

$E_{av}$  [fc]  
 0.47

$E_{min}$  [fc]  
 0.04

$E_{max}$  [fc]  
 2.02

$u_0$   
 0.09

$E_{min} / E_{max}$   
 0.02

Greenshine New Energy  
 23661 Birtcher Dr  
 Lake Forest, CA 92630

Operator Luis Jimenez  
 Telephone 949-609-9636 X 104  
 Fax  
 e-Mail luis.jimenez@streetlights-solar.com

### LUMINA 30W - 20' POLE / Calculation Grid 1 / Value Chart (E, Perpendicular)

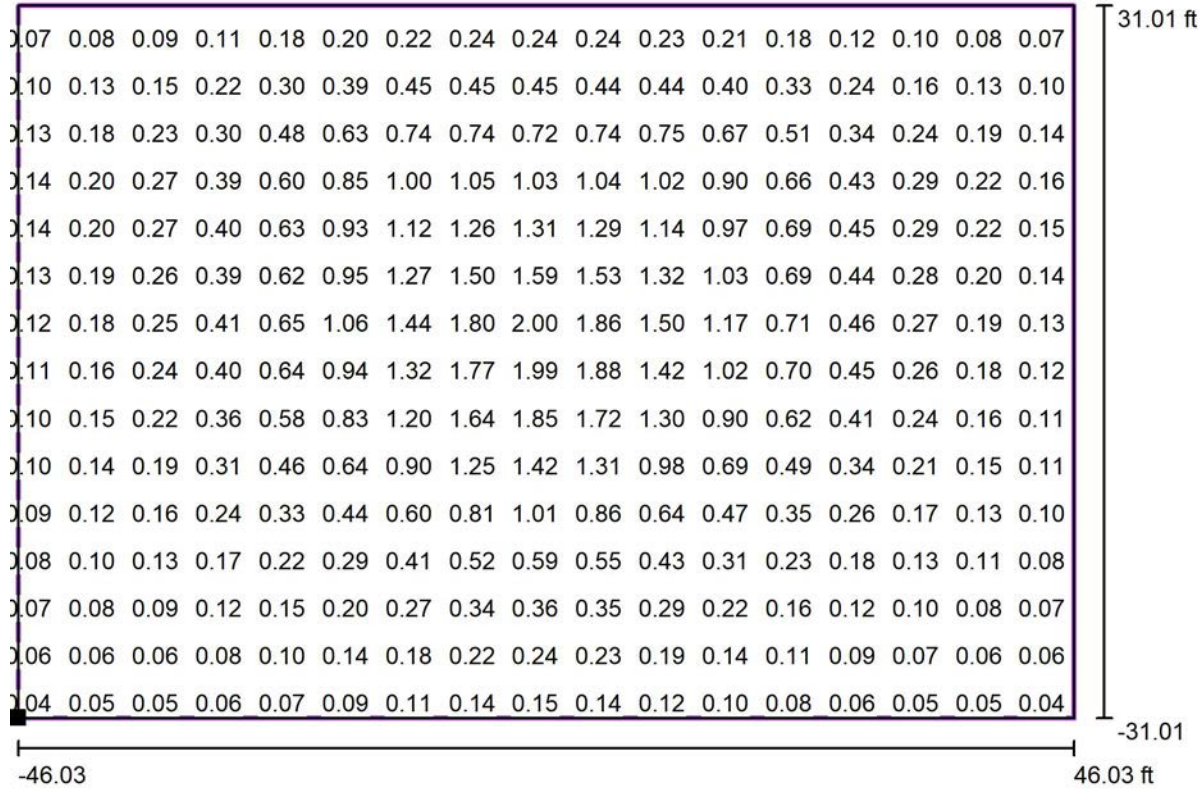

Values in Footcandles, Scale 1 : 201

Not all calculated values could be displayed.

Position of surface in external scene:  
 Marked point: (126.012 ft, 144.319 ft, 0.000 ft)



Grid: 50 x 30 Points

$E_{av}$  [fc]  
0.47

$E_{min}$  [fc]  
0.04

$E_{max}$  [fc]  
2.02

u0  
0.09

$E_{min} / E_{max}$   
0.02

# GREENSHINE NEW ENERGY



Greenshine

## 5 YEAR LIMITED WARRANTY

Greenshine New Energy provides a 5 year limited warranty on its solar lighting system. Greenshine will, at its option, repair or replace any Greenshine system that is defective. Additionally, certain components within Greenshine's system have extended warranty protection against failure as defined below:

COMPONENT	WARRANTY
*Solar Panel	20 Years
Pole and Mounting Brackets	5 Years
LED Light Fixture	5 Years
Electronics (Controller, driver)	5 Years
**Battery	5 Years

\* Greenshine New Energy warrants that the power output of the PV Modules will be at least 80% of the minimum Peak Power rating for 20 years, and warrants that for 20 years beginning on the Warranty Start Date, its photovoltaic modules, shall be free from defects in materials and workmanship under normal application, installation, use and service conditions.

Specific restrictions may apply due to site-specific conditions, please check quote's details for more information.

This warranty does not cover damage or malfunction, as determined by Greenshine service technicians or engineers, due to abuse, misuse, incorrect installation, or accident such as, but not limited to:

- Failure to follow storage, installation, operation, and maintenance instructions provided by Greenshine
- Vandalism, theft, lightning, flood, "Acts of God", and other problems beyond the control of Greenshine
- Unauthorized or improper repairs or adjustments including use of any replacement parts not provided by Greenshine.
- Deployed in an abnormal or inconsistent manner from Greenshine New Energy written and verbal instructions
- Greenshine New Energy liability and Purchaser's remedy under Greenshine New Energy warranty is limited to the replacement of any defective item, but under no circumstance shall exceed the purchase price of the goods. Other warranties may be available for an additional cost with additional coverage and/or labor allowance included.
- Any repair cost not approved by Greenshine New Energy will not be reimbursed.
- Purchaser is responsible for any and all costs involved to service and/or replace defective good including labor, shipping, and rental of equipment.

\*\*Greenshine New Energy provides a limited warranty for battery replacement with the following prorated coverage:

- 0 to 2 years: 100% credit (user pays 0% of the replacement battery price)
- 2 to 3 years: 60% credit (user pays 40% of the replacement battery price)
- 3 to 4 years: 40% credit (user pays 60% of the replacement battery price)
- 4 to 5 years: 20% credit (user pays 80% of the replacement battery price)