



 Greenshine

OUTDOOR SOLAR LIGHTING SOLUTIONS



LITA



Light Fixture (GS-LED-L30)

Luminaire Input Voltage	DC 12V
Power Consumption	20W
Lumen	2119 lumens
Color Temperature	3000-4000 K
IES Lighting Type	Type II III V
Material	Die-cast aluminum



Solar Panel (1 or 2 Units)

110W

180W

Rating Power	110 W	180 W
Maximum Power Voltage	17.60 V	18.95 V
Maximum Power Current	6.25 A	9.50 A
Open Circuit Voltage	21.7 V	22.74 V
Short Circuit Current	6.71	9.98
Size	47.5" x 27"	58.5" x 27"
Weight	23.4 lb	29.5 lb

Battery (1 or 2 Units)

Battery Type	GEL Deep Cycle Lead-Acid
Operating Voltage	12 V
Capacity	80 Ah at 20 hr-rate to 1.75 V per cell at 77°F
Dimensions	13(L)×7(W)×8.5(H) (in)
Expected Life	5 ~ 7 years

Solar Charger

Operating Voltage	12 V/24 V auto recognition
Max. Charge / Load Current	5 A/ 10 A/ 20 A (different models)
Night / Day Detection	2.5 V – 10 V
IP Class	IP68

Pole

Height	14 ft
Diameter	5.5" at the bottom, 3" at the top
Thickness	5/32"
Material	Galvanized Steel
Finishing	Powder Coating





SPECIFICATIONS

Luminaire Input Voltage
Power Consumption
Lumen Output
Color Temperature
IES Lighting Type
Material
Lens
IP Class
Insulation
Operating Temperature
CRI

DC 12V | 24V
20W
2119 lumens
3000-4000 K
Type II | III | V
High pressure die-cast aluminum
5mm toughened glass, optical grade PMMA
IP 65
Class I
-30°C ~+50°C / -22°F ~+122°F
≥70

Weight: 8.3 kg | 18.3 lb

DIMENSIONS

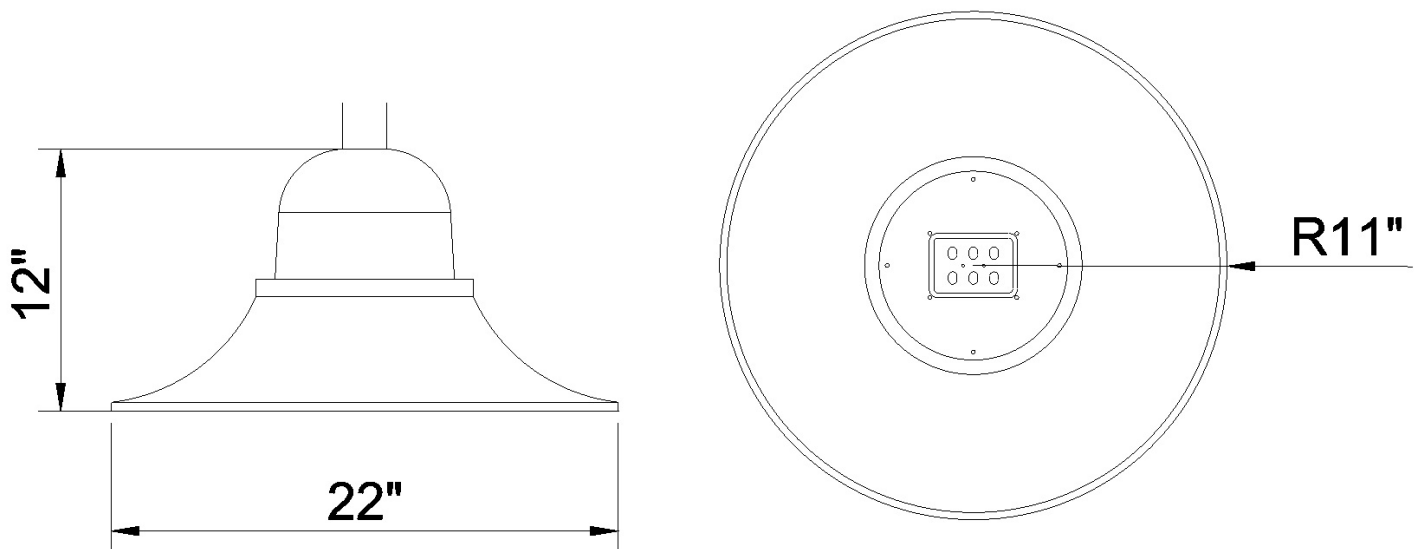



Greenshine

LITA SERIES

Solar Powered LED Lighting System

OVERVIEW

The Lita Series features customizable outdoor solar light solutions depending on your specific application and an adjustable mounting bracket. Each system is completely customized according to your location, project and lighting requirements; also systems can be configured to run throughout the night or have them dim to save energy when full light is not required and with the option for a motion detection.

PART NUMBER

SYSTEM	LUM. QTY.	LUMINAIRE	OPTICS	LOAD	COLOR TEMP.	ARM	BOX QTY.
LA Lita	1 Single 2 Dual	LI Lita	T2 Type 2 T3 Type 3 T5 Type 5	20W ##	3K 3000 Kelvin 4K 4000 Kelvin 5K 5000 Kelvin	SH Shepherd's Hook	1 1 Box 2 2 Boxes
BATTERY QTY.	BATT. MNT.	BATTERY	PV QTY.	PV WATT	POLE HEIGHT	COLOR	OPERATING PROFILE
1 1 Battery 2 2 Batteries	H High L Low BB Burried Battery PB Pole Base	40 40 amp 120 120 amp 150 150 amp 200 200 amp	1 Single 2 Dual	110W 180W	P14 14ft P# Custom	BK Black BZ Bronze C# Custom	5/40 DIM 6/40 DIM 7/40 DIM 8/40 DIM D2D

FIXTURES

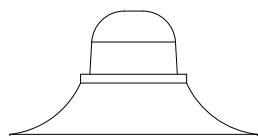

Lita
20W
TYPE 2, 3 & 5

Decorative Luminaire Series available. See Decorative Data-sheets for more info.

SPECIFICATIONS

- ▶ **Luminaire**
 - 60,000 hours.
 - 3000K - 5000K available with standard 4000K.
 - Turtle Friendly compliant fixtures available.
- ▶ **Panel Mount**
 - Rated to 145mph. 185mph available.
- ▶ **Solar Panel**
 - Mono-crystalline Photovoltaic solar panels.
- ▶ **Battery Enclosure**
 - Vented, corrosion resistant stainless steel battery box.
 - Holds battery and controller.
 - Includes lock.
- ▶ **GEL-Type Battery**
 - Greenshine Battery - Maintenance-free 99% recyclable.
 - 40Ah - 200Ah seal GEL Cell batteries.
- ▶ **Smart Controller**
 - Controller - Solar Charge controller that monitors and regulates charging and discharging of batteries. Also, programable to specific operating profile for project.
- ▶ **5 Year Limited Warranty**
 - Includes 10 year warranty on solar panel. 5 and 10 Year Full Warranty available.

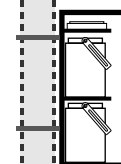
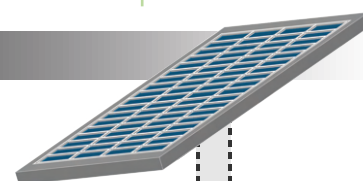

GREENSHINE SOLAR PANEL

Solar Powered LED Lighting System



Greenshine

OVERVIEW

- Mono-Crystalline solar cells
- Aluminum frame with a unique design to withstand strong winds
- Highly resistant tempered glass
- Multilayer EVA encapsulation with triple layer back sheet
- 25-year power output warranty: 5 years/95%, 12 years/90%, 25 years/80%.

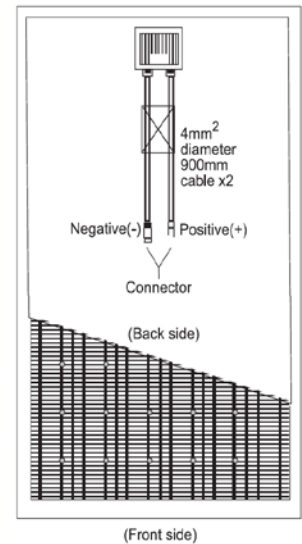

Rating Power	110W	180W
Product Tolerance	± 3%	± 3%
Maximum Power Voltage	17.60V	18.95V
Maximum Power Current	6.25A	9.50A
Open Circuit Voltage	21.7 V	22.74 V
Short Circuit Current	6.71 A	9.98 A
Frame	Anodized aluminum, 4mm thickness	
Dimensions	1208mm x 682mm 47.5" x 27" 10.6kg 23.4lb	1486mm x 682mm 58.5" x 27" 13kg 29.5lb
Test Temperature	25°C 77°F, 1000w/m ² , Air Mass 1.5	
Junction Box / Wiring	IP65 Junction box with 900mm cable with MC4 connectors	



LITA SERIES

Solar Powered LED Lighting System



TECHNICAL

Description	Mount Dimensions (L x W)	Solar Panel	PV Dimensions (L x W)	EPA @ 45° Power Unit	System Weight	Pole Tenon
SINGLE	1208mm x 682mm 47.5" x 27"	110W	1208mm x 682mm 47.5" x 27"	0.8 sq meter	25kg 55lb	3" O.D 76mm O.D
	1486mm x 682mm 58.5" x 27"	180W	1486mm x 682mm 58.5" x 27"	1 sq meter	38kg 83lb	3" O.D 76mm O.D
DUAL	1208mm x 1400mm 47.5" x 55"	110W	1208mm x 682mm 47.5" x 27"	1.6 sq meter	27kg 60lb	3" O.D 76mm O.D
	1486mm x 1400mm 58.5" x 55"	180W	1486mm x 682mm 58.5" x 27"	2 sq meter	43kg 94lb	3" O.D 76mm O.D

MOUNTS

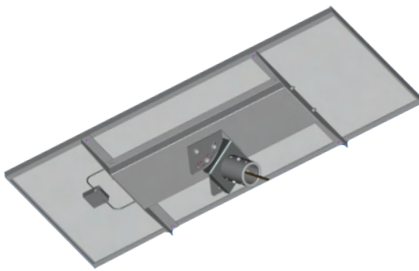

SINGLE MOUNT

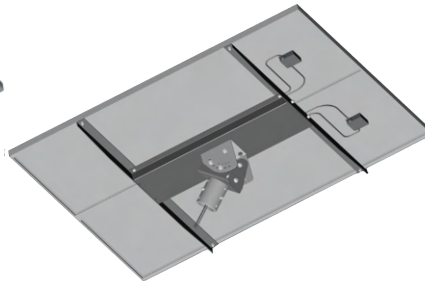

DUAL MOUNT

ARMS

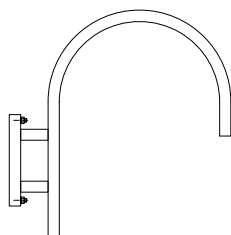

Shepherd's Hook

GREENSHINE GEL-TYPE BATTERY

Solar Powered LED Lighting System



Greenshine

OVERVIEW

GEL deep cycle battery with a 12 years floating design life is especially designed for frequent cyclic discharge under extreme temperature.



	GS-GEL-H40	GS-GEL-H120	GS-GEL-H150	GS-GEL-H200
Cells per unit	6	6	6	6
Voltage per unit	12V	12V	12V	12V
Capacity	40Ah @ 20hr-rate to 1.80V per cell @ 25°C / 77°F	120Ah @ 20hr-rate to 1.75V per cell @ 25°C / 77°F	150Ah @ 20hr-rate to 1.75V per cell @ 25°C / 77°F	200Ah @ 20hr-rate to 1.75V per cell @ 25°C / 77°F
Weight	12.3kg / 28lb	38kg / 84lb	46kg / 100lb	59.2kg / 131.5lb
Dimensions L x W x H	196 x 165 x 174(mm) 7.5" x 6.5" x 6.8"	406 x 173 x 233(mm) 16" x 7" x 9.2"	483 x 170 x 240(mm) 19" x 6.7" x 9.5"	522 x 240 x 218(mm) 20.5" x 9.44" x 8.7"
Max Discharge Current	800A (5 Sec)	1200A (5 Sec)	1500A (5 Sec)	2000A (5 Sec) ²
Operating Temp. range	-35°C~60°C -31°F~140°F			
Flot Charging Voltage	13.6 to 13.8 VDC / unit average at 25°C / 77°F			
Recommended max. charging current	10A	24A	30A	40A
Self-discharge	Valve Regulated Lead Acid can be stored for more than 6 months at 25°C/77°F. Self-discharge ratio less than 3% per month at 25°C/77°F. Please charge batteries before using.			
Equalization and cycle service	14.6 to 14.8 VDC / unit average at 25°C / 77°F			
Terminal type	5ft cooper wire leads from the battery case			



Greenshine

GREENSHINE GEL-TYPE BATTERY

Life characteristics of cyclic use

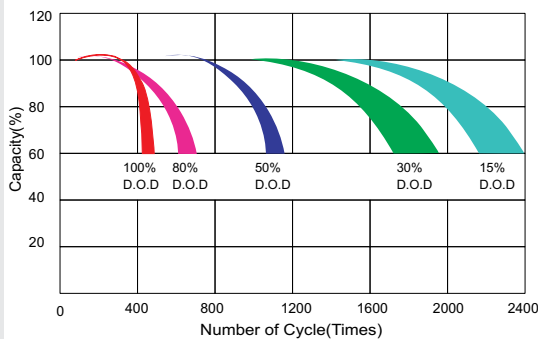

Storage characteristic

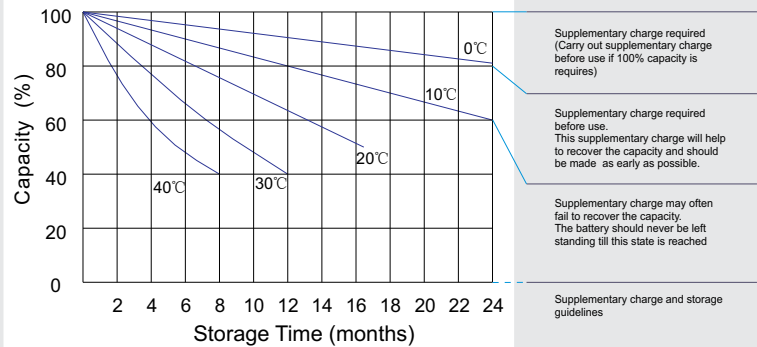

Supplementary charge required (Carry out supplementary charge before use if 100% capacity is required)

Supplementary charge required before use. This supplementary charge will help to recover the capacity and should be made as early as possible.

Supplementary charge may often fail to recover the capacity. The battery should never be left standing till this state is reached

Supplementary charge and storage guidelines

Charge characteristic curve for cyclic use

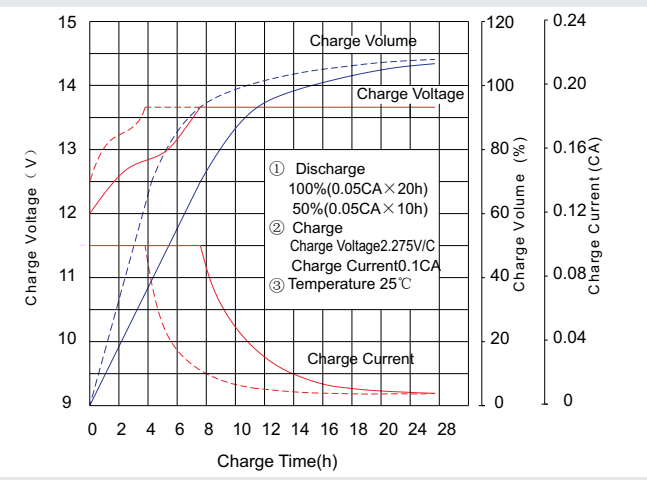

Discharge characteristic curve

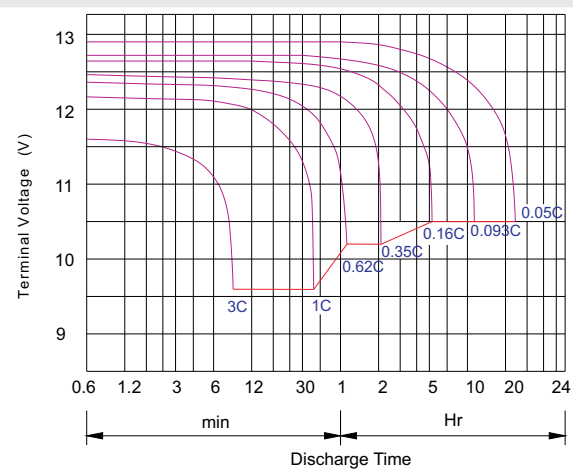

Capacity Factors With Different Temperature

Battery Type		-20°C	-10°C	0°C	5°C	10°C	20°C	25°C	30°C	40°C	45°C
GEL Battery	6V&12V	50%	70%	83%	85%	90%	98%	100%	102%	104%	105%
	2V	60%	75%	85%	88%	92%	99%	100%	103%	105%	106%
AGM Battery	6V&12V	46%	66%	76%	83%	90%	98%	100%	103%	107%	109%
	2V	55%	70%	80%	85%	92%	99%	100%	104%	108%	110%

Discharge Current VS. Discharge Voltage

Final Discharge Voltage V /cell	1.75V	1.70V	1.60V
Discharge Current (A)	(A) ≤0.2C	0.2C < (A) <1.0C	(A) ≥1.0C

Charge the batteries at least once every six months, if they are stored at 25°C.

Charging Method:

Constant Voltage	-0.2Cx2h+14.4-14.7Vx24h, Max. Current 0.2C
Constant Current	-0.2Cx2h+0.1Cx12h
Fast	-0.2Cx2h+0.2Cx6h

Bolt	M5	M6	M8
Terminal	F3 F4 F13 F18 T25 T26	F8 F11 F12-1 F15	F5 F9 F10 F12 F14 F16
Torque	6-7N-m	8-10N-m	10-12N-m

Maintenance & Cautions

Cycle service
※ Avoid battery over discharge, especially battery series connection use.
※ Charged with recommend voltage, ensure battery can be full recharged.
In general, recharge capacity should be 1.1-1.15 times discharge capacity.
※ Effect of temperature on cycle charge voltage: -4mV/°C/Cell.
※ There are a number of factors that will affect the length of cyclic service.
The most significant are depth of discharge, ambient temperature, discharge rate, and the manner in which the battery is recharged.
Generally speaking, the most important factors is depth of discharge.

BATTERY ENCLOSURE

OVERVIEW

- Housing - Made of 201 stainless steel with powder coating finish unit that holds battery and smart controller. Vented to allow air circulation around batteries. Easy access through hinged/removable front cover to allow quick servicing or battery replacement. Maintenance-free 99% recyclable.
- Mounting - Mounted to Pole at low, mid or high placements.
- Battery - Our battery enclosures are designed to fit our 80Ah, 120Ah, 150Ah and 200Ah GEL TYPE batteries.
- Five Year System Warranty - Includes five year limited warranty on batteries.
- Controller - Mounted inside of hinged battery enclosure for ease of maintenance.
- The Battery Box is a stainless steel enclosure that has a lock for additional security.

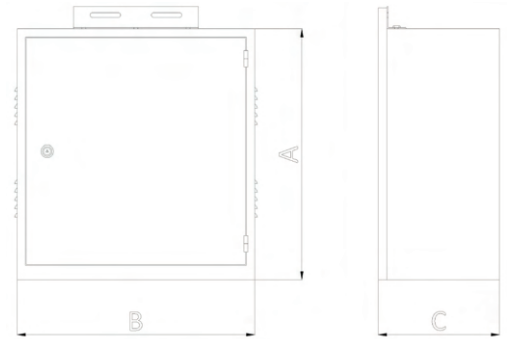
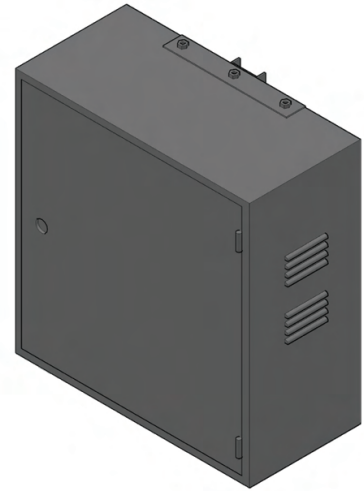

TYPE	# OF BATTERIES	DIMENSIONS: L x W x D (A x B x C)	WEIGHT	EFFECTIVE PROJECTED AREA (EPA)
1150	1 X 150AH	15.75"x22.4"x10.6" (inch) 40x57x27 (cm)	30 lb 13.6 kg	3.43 sq ft 0.319 m2
1200	1 X 200AH	15.75"x23.6"x12.2" (inch) 40x60x31 (cm)	35 lb 15.8 kg	3.61 sq ft 0.336 m2
2150	2 X 150AH	23.5"x22.4"x10.6" (inch) 60x57x27 (cm)	40 lb 18.1 kg	5.11 sq ft 0.476 m2
2200	2 X 200AH	24.4"x23.6"x12.6" (inch) 62x60x32 (cm)	45 lb 20.4 kg	5.58 sq ft 0.518 m2

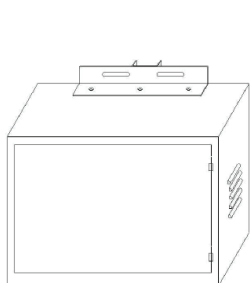

1 X 150AH

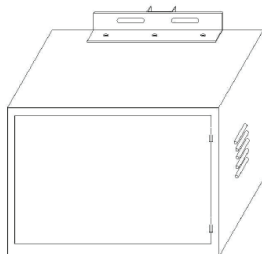

1 X 200AH

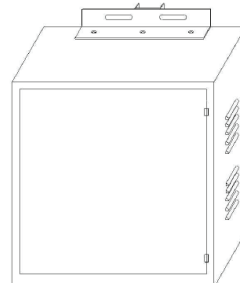

2 X 150AH

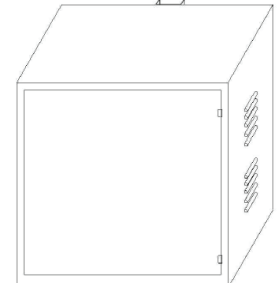

2 X 200AH

BURIED BATTERY ENCLOSURE

OVERVIEW

- Housing - Made of 201 stainless steel with powder coating finish unit that holds battery and smart controller. Vented to allow air circulation around batteries. Easy access through hinged/removable front cover to allow quick servicing or battery replacement. Maintenance-free 99% recyclable.
- Placement - Buried Battery Box.
- Battery - Our battery enclosures are designed to fit our 80Ah, 120Ah, 150Ah and 200Ah GEL TYPE batteries.
- Five Year System Warranty - Includes five year limited warranty on batteries.
- Controller - Mounted inside of hinged battery enclosure for ease of maintenance.
- The Battery Box is a stainless steel enclosure that has a lock for additional security.

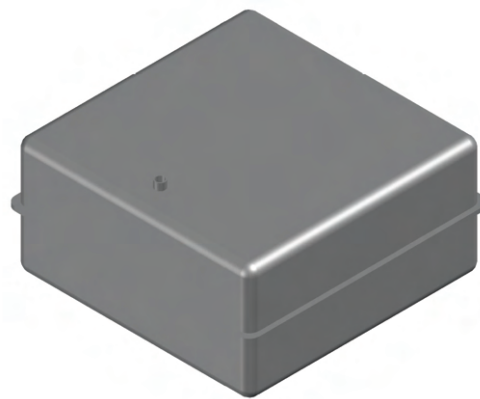

TYPE	# OF BATTERIES	DIMENSIONS: L x W x D (A x B x C)	WEIGHT	EFFECTIVE PROJECTED AREA (EPA)
1200	1 X 200AH	1' x 1' x 2' (ft) 30.5 x 30.5 x 61 (cm)	30 lb 13.6 kg	2 sq ft 0.319 m ²
2200	2 X 200AH	1' x 2' x 2' (ft) 30.5 x 61 x 61 (cm)	35 lb 15.8 kg	4 sq ft 0.336 m ²

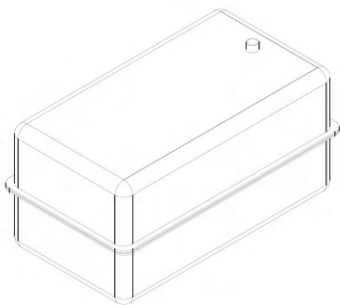

1 X 200AH

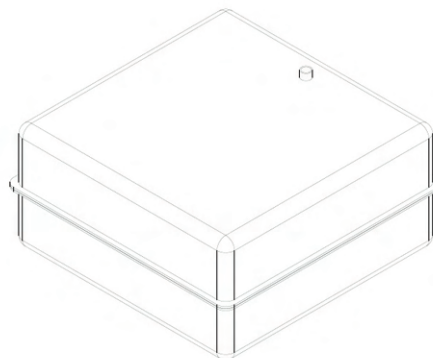

2 X 200AH

GREENSHINE CONTROLLER

Solar Powered LED Lighting System



Greenshine

FEATURES

- Corrosion-proof epoxy-encapsulated PCB (IP68)
- Four-stage battery charging (main, float, boost, equalization)
- Temperature compensated
- Automatic system voltage recognition (12V/24V)
- Customized by Greenshine to fit specific needs of clients
- Easy to install

SPECIFICATIONS

System Voltage

12V | 24 Auto Recognition

Max. charge / load current

5A | 10A | 20A (Different Models)

Deep discharge protection:

Cut-off Voltage

11V - 12V | 22V - 24V

Reconnect Level

12.8V | 25.6V

Overvoltage Protection

15.5V | 31.0V

Undervoltage Protection

10.5V | 21V

Max. Panel Voltage

$U_{BATmin} + 30V$ (if module and battery are connected with correct polarity)

Temperature compensation

-25mV | K at 12V

(Charge Voltage)

-50mV | K at 24V

Ambient Temperature

-40°C to +60°C, -40°F to +140°F

Max. Altitude

4,000m above sea level

Battery Type

Lead acid (GEL, AGM, flooded)

Adjustment Range:

Evening / Morning Hours

0 - 15h | 0 - 14h

Night / Day Detection

2.5V - 10V

Wire Cross Section

1.5mm²/ 1.5mm²/ 2.5mm², 15 (AWG)

Type of Protection

IP68 (1.5 m, 72 h)



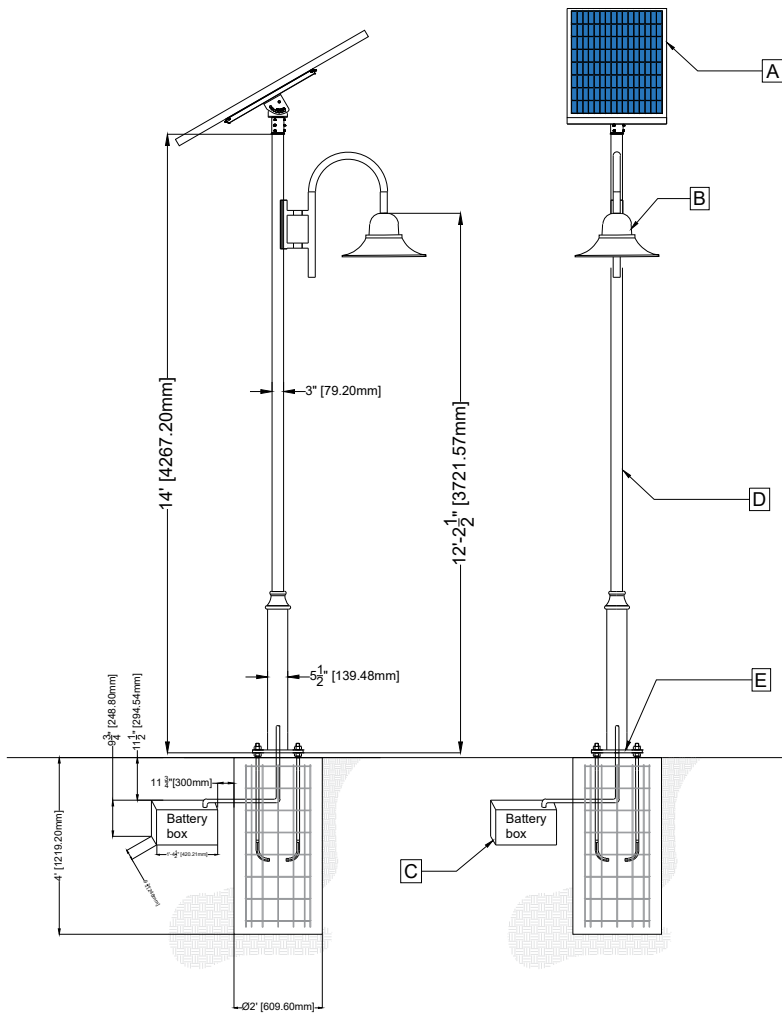

- LEGEND**
- A. Mono-Crystalline Solar Cell - Solar Panel; Orient towards True South per manufacturer's recommendation.
 - B. Luminaire
 - C. Battery Box
 - D. 5 1/2" at the bottom, 3" at the top - Galvanized Steel Pole
 - E. Flange

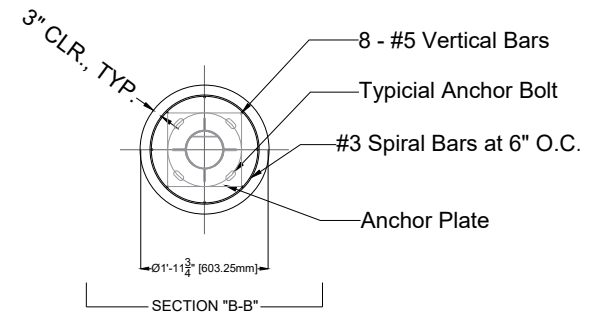
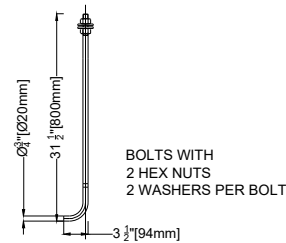
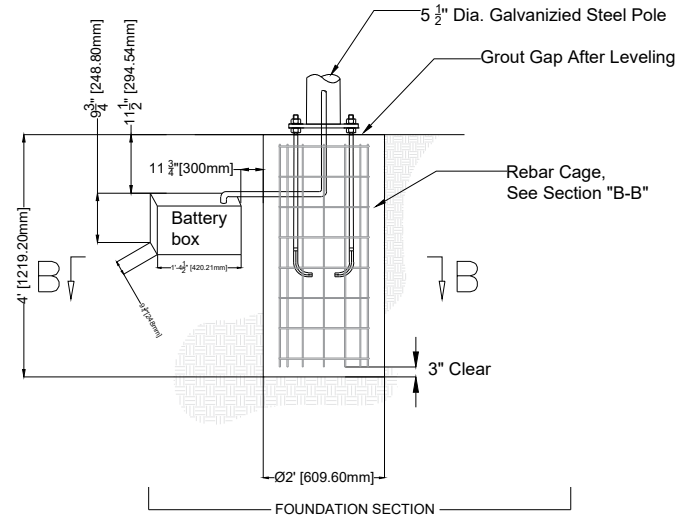

ANCHOR BOLT DETAIL

SECTION "B-B"

SECTION "A-A"

Flange Detail

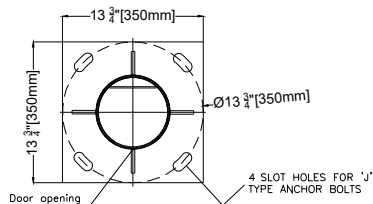

- Foundation dimensions shall be confirmed by a local engineering company, Greenshine New energy will not be held liable for any defect of the concrete foundation due to improper sizing.
 - Drawings are based using hot-dipped galvanized steel, powder coating with a thickness of 0.02"
 - *EPA of the system exclude the EPA of the pole, includes the solar panels, brackets, arm and LED fixture and battery box.
 - **Wind resistance of the poles are indicative and further customization can be provided.

Tilt angle of the solar panels	15	30	45	60
EPA (ft ²)*	3.94	7.58	10.76	13.13
Wind resistance** (mph)	150	150	150	150

System	Lita - 14' - 1P
By	Luis Jimenez
Date	4/23/2021
Website	www.streetlights-solar.com

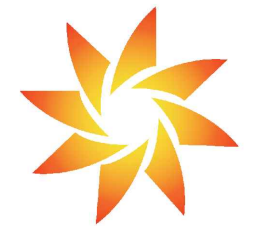

Greenshine

Project 1



03 / 23 / 2020

Greenshine New Energy

23661 Birtcher Dr
Lake Forest, CA 92630

Operator Luis Jimenez
Telephone 949-609-9636 X 104
Fax
e-Mail luis.jimenez@streetlights-solar.com

LITA 20W - 14' POLE / 3D Rendering

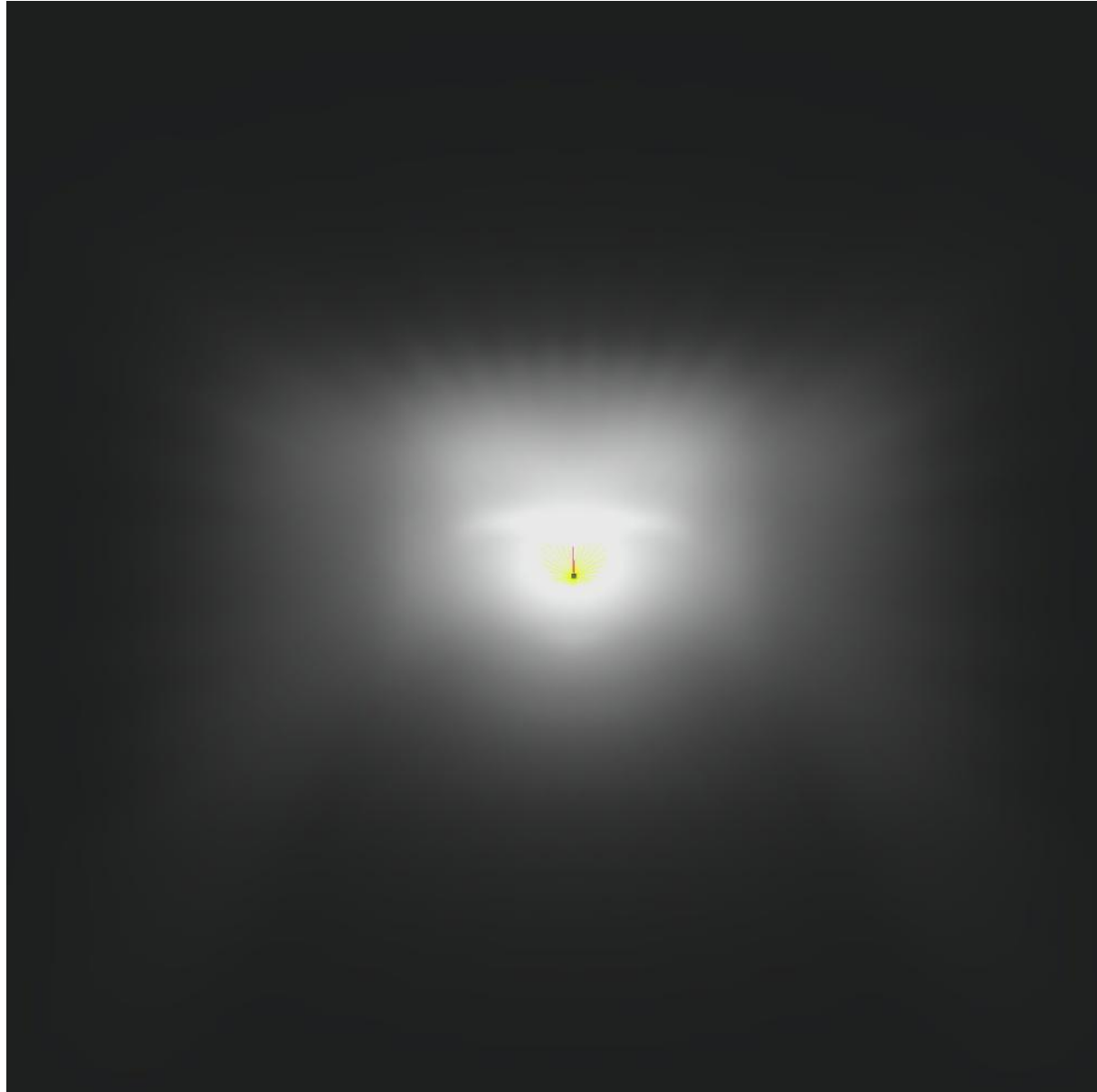



Greenshine New Energy
23661 Birtcher Dr
Lake Forest, CA 92630

Operator Luis Jimenez
Telephone 949-609-9636 X 104
Fax
e-Mail luis.jimenez@streetlights-solar.com

LITA 20W - 14' POLE / False Color Rendering

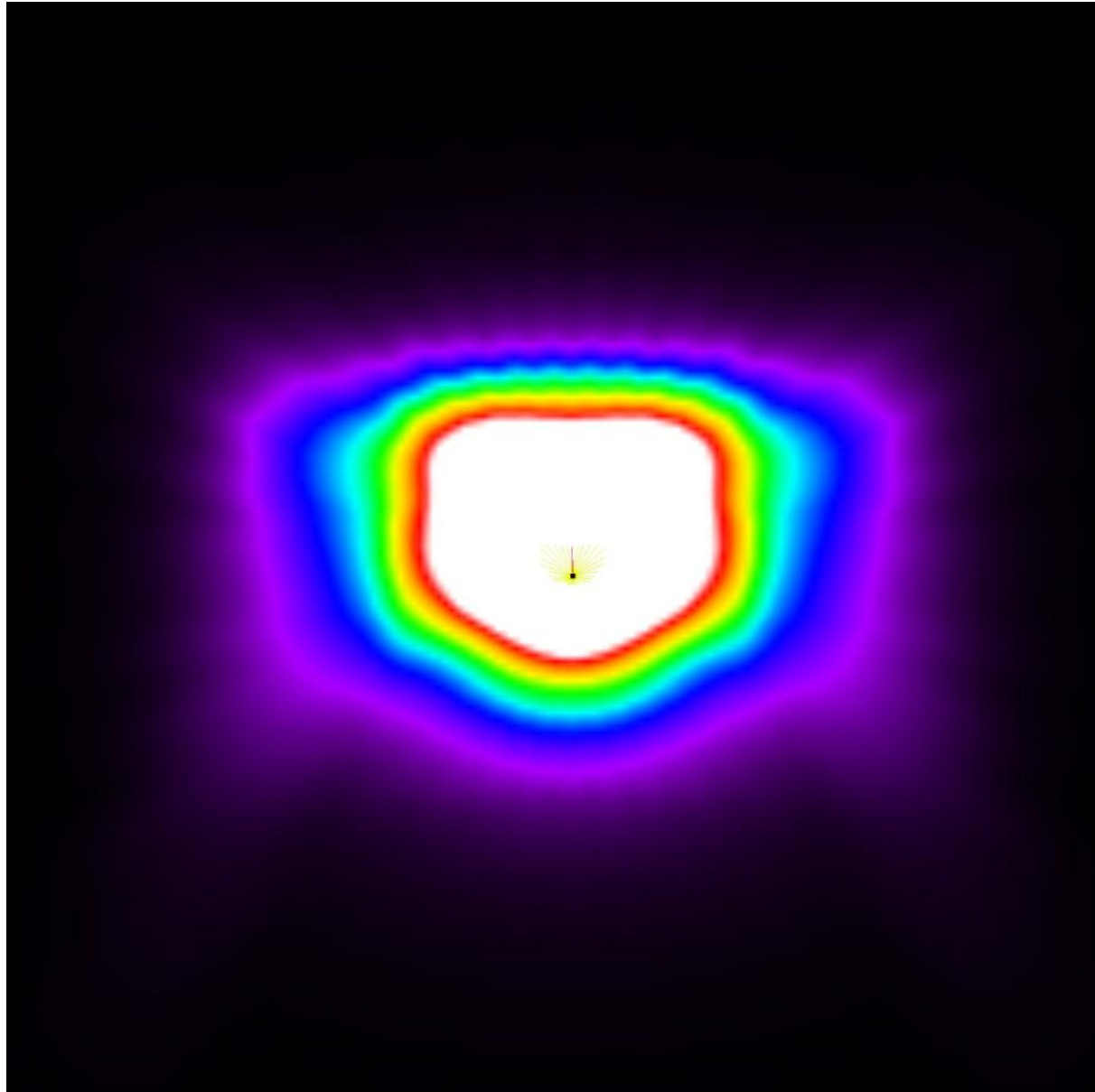

0 0.13 0.25 0.38 0.50 0.63 0.75 0.88 1.00 fc

Greenshine New Energy
 23661 Birtcher Dr
 Lake Forest, CA 92630

Operator Luis Jimenez
 Telephone 949-609-9636 X 104
 Fax
 e-Mail luis.jimenez@streetlights-solar.com

LITA 20W - 14' POLE / Calculation Grid 1 / Isolines (E, Perpendicular)

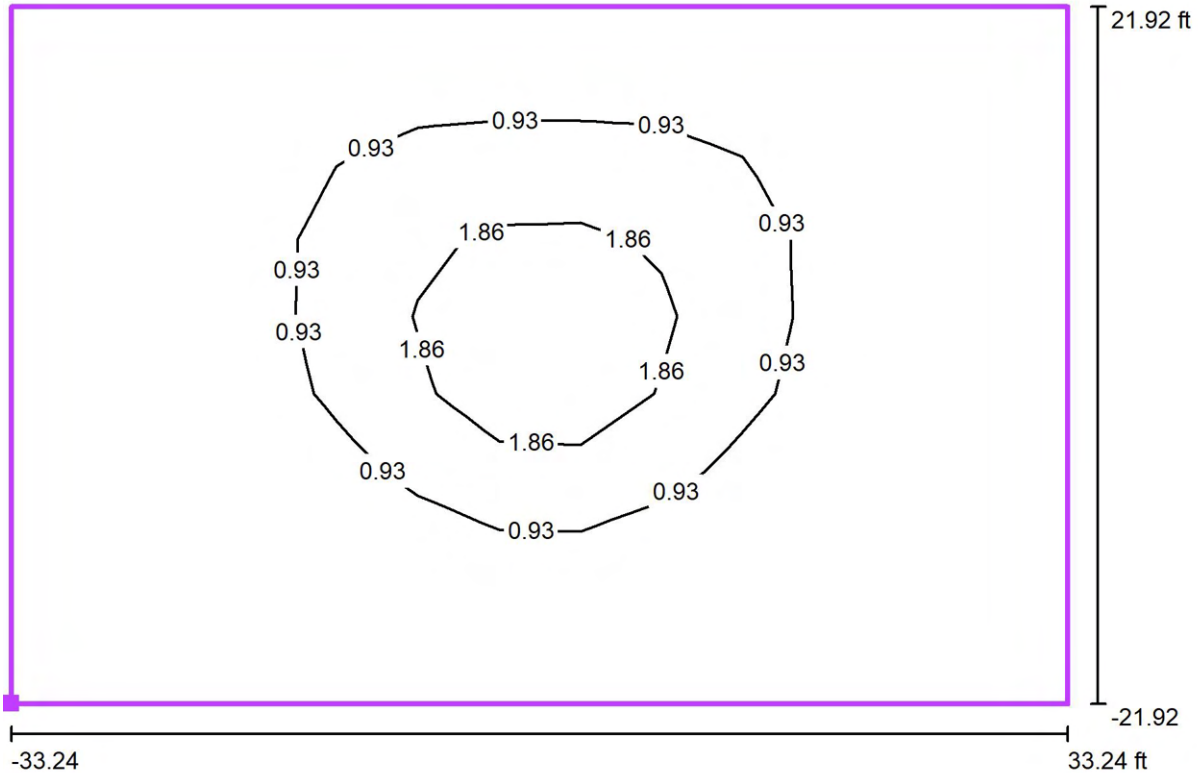

Values in Footcandles, Scale 1 : 145

Position of surface in external scene:
 Marked point: (138.174 ft, 151.724 ft,
 0.000 ft)

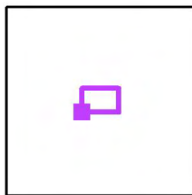

Grid: 13 x 9 Points

E_{av} [fc]	E_{min} [fc]	E_{max} [fc]	u0	E_{min} / E_{max}
0.61	0.06	2.90	0.10	0.02

Greenshine New Energy
 23661 Birtcher Dr
 Lake Forest, CA 92630

Operator Luis Jimenez
 Telephone 949-609-9636 X 104
 Fax
 e-Mail luis.jimenez@streetlights-solar.com

LITA 20W - 14' POLE / Calculation Grid 1 / Value Chart (E, Perpendicular)

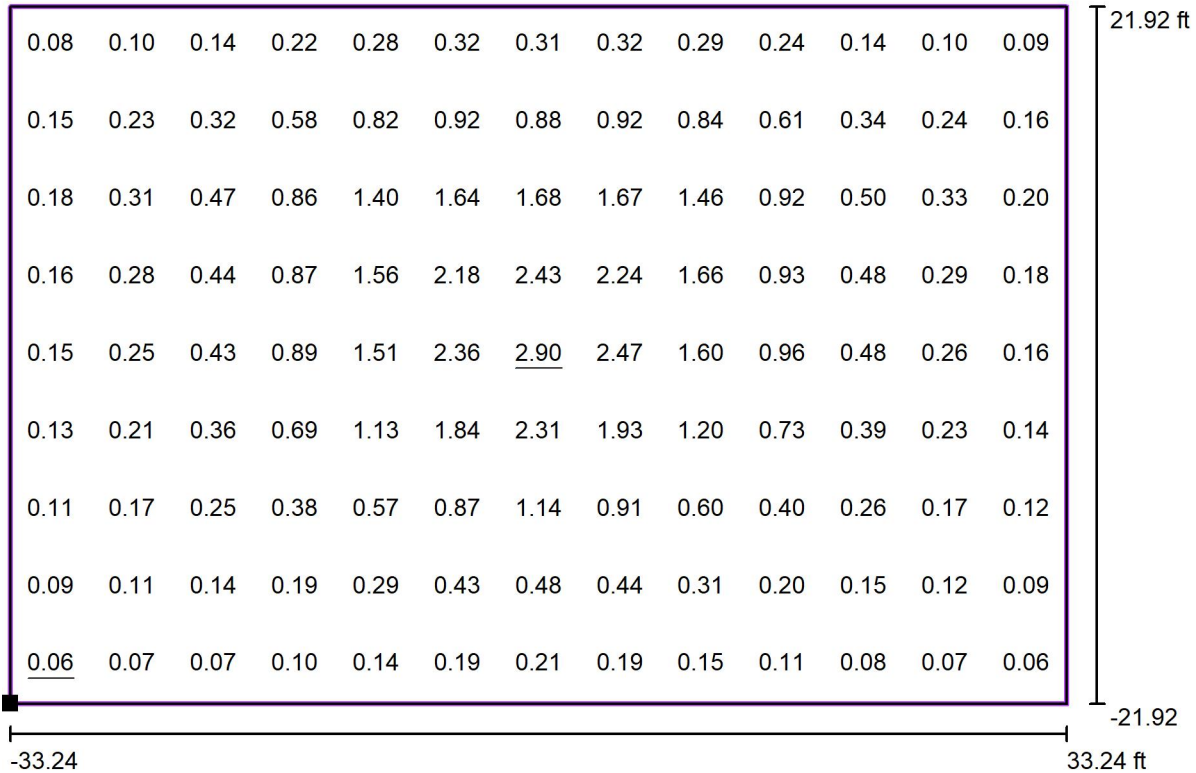

Values in Footcandles, Scale 1 : 145

Position of surface in external scene:
 Marked point: (138.174 ft, 151.724 ft,
 0.000 ft)

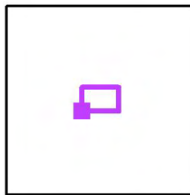

Grid: 13 x 9 Points

E_{av} [fc]
 0.61

E_{min} [fc]
 0.06

E_{max} [fc]
 2.90

u_0
 0.10

E_{min} / E_{max}
 0.02

GREENSHINE NEW ENERGY



Greenshine

5 YEAR LIMITED WARRANTY

Greenshine New Energy provides a 5 year limited warranty on its solar lighting system. Greenshine will, at its option, repair or replace any Greenshine system that is defective. Additionally, certain components within Greenshine's system have extended warranty protection against failure as defined below:

COMPONENT	WARRANTY
*Solar Panel	20 Years
Pole and Mounting Brackets	5 Years
LED Light Fixture	5 Years
Electronics (Controller, driver)	5 Years
**Battery	5 Years

* Greenshine New Energy warrants that the power output of the PV Modules will be at least 80% of the minimum Peak Power rating for 20 years, and warrants that for 20 years beginning on the Warranty Start Date, its photovoltaic modules, shall be free from defects in materials and workmanship under normal application, installation, use and service conditions.

Specific restrictions may apply due to site-specific conditions, please check quote's details for more information.

This warranty does not cover damage or malfunction, as determined by Greenshine service technicians or engineers, due to abuse, misuse, incorrect installation, or accident such as, but not limited to:

- Failure to follow storage, installation, operation, and maintenance instructions provided by Greenshine
- Vandalism, theft, lightning, flood, "Acts of God", and other problems beyond the control of Greenshine
- Unauthorized or improper repairs or adjustments including use of any replacement parts not provided by Greenshine.
- Deployed in an abnormal or inconsistent manner from Greenshine New Energy written and verbal instructions
- Greenshine New Energy liability and Purchaser's remedy under Greenshine New Energy warranty is limited to the replacement of any defective item, but under no circumstance shall exceed the purchase price of the goods. Other warranties may be available for an additional cost with additional coverage and/or labor allowance included.
- Any repair cost not approved by Greenshine New Energy will not be reimbursed.
- Purchaser is responsible for any and all costs involved to service and/or replace defective good including labor, shipping, and rental of equipment.

**Greenshine New Energy provides a limited warranty for battery replacement with the following prorated coverage:

- 0 to 2 years: 100% credit (user pays 0% of the replacement battery price)
- 2 to 3 years: 60% credit (user pays 40% of the replacement battery price)
- 3 to 4 years: 40% credit (user pays 60% of the replacement battery price)
- 4 to 5 years: 20% credit (user pays 80% of the replacement battery price)