

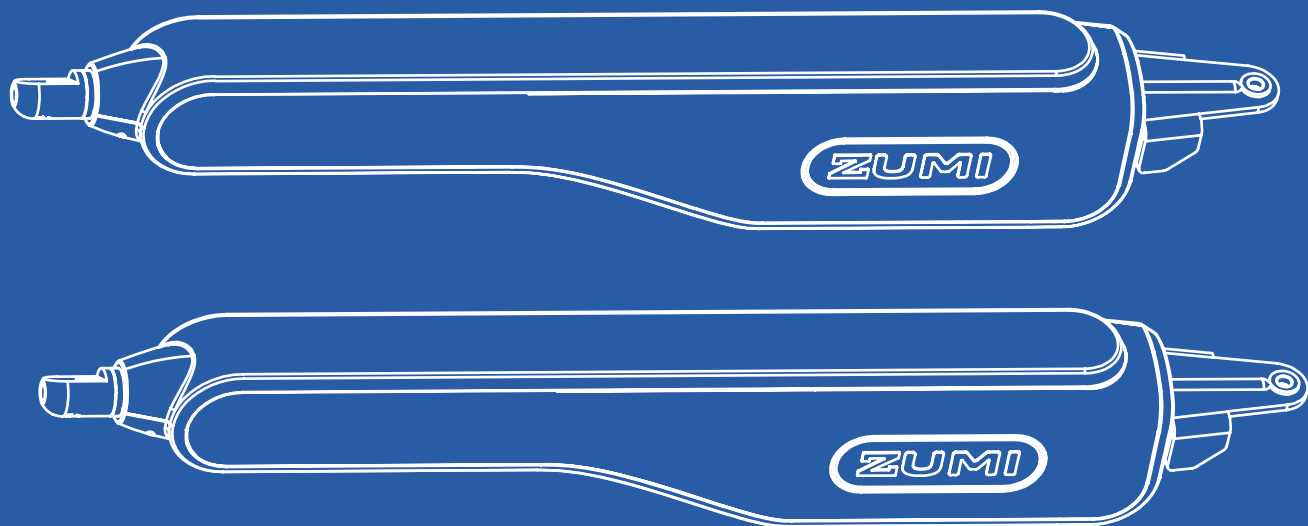

WS2 SWING GATE OPENER

USER MANUAL



Read Carefully Before Use
Keep for Future Reference

TABLE OF CONTENTS



1	Safety	1
1.1	Symbol Guide	1
1.2	General Safety	1
1.3	Designated Use	2
1.4	Electrical Safety	2
1.5	Gate Requirements	3
1.6	Entrapment Countermeasures	3
2	About the Product	5
2.1	Package List	5
2.2	Specifications	9
3	Installation	10
3.1	Typical Installation Overview	10
3.2	Pre-Installation Check	12
3.3	Push-to-Open Installation (PSO)	13
3.3.1	Locating the Center Line	13
3.3.2	Post Bracket Pre-Assembly and Location	15
3.3.3	Mounting the Post Bracket	17
3.3.4	Connecting the Actuator	18
3.3.5	Mounting the Control Box	19
3.3.6	Wiring the Actuator	21
3.3.7	Mounting the Front Bracket	25
3.3.8	Installing the Limit Stop	29
3.3.9	Installing a Second Actuator	30
3.3.10	Programing	31
3.3.11	Display Parameters and Message Codes	43
3.4	Pull-to-Open Installation (PLO)	47
3.4.1	Locating the Center Line	47
3.4.2	Post Bracket Pre-Assembly and Location	48
3.4.3	Mounting the Post Bracket	50
3.4.4	Connecting the Actuator	51
3.4.5	Mounting the Control Box	52
3.4.6	Wiring the Actuator	54
3.4.7	Mounting the Front Bracket	58

3.4.8	Installing the Limit Stop	63
3.4.9	Installing the Second Actuator	64
3.4.10	Programing	65
3.4.11	Display Parameters and Message Codes	77
4	Using the App	81
4.1	Log In	81
4.2	Adding a Device	82
4.2.1	Adding a Device via QR Code	82
4.2.2	Adding a Device via Bluetooth	83
4.3	Managing Members and Devices	84
4.4	Setting Up Intelligent Scene	86
4.5	Viewing Gate Opening and Closing Records	88
4.6	Others	89
4.6.1	Settings	89
4.6.2	Information & Feedback	91
5	Maintenance	93
6	Troubleshooting	94
7	Disposal	95

1 SAFETY

1.1 Symbol Guide

Get familiar with the connotations of these safety symbols before reading the next page. They comprise important precautions against personal injuries and property damages.

 Danger	Indicates an imminently hazardous situation which, if not avoided, WILL result in death or serious injury.
 Warning	Indicates a potentially hazardous situation which, if not avoided, COULD result in death or serious injury.
 Caution	Indicates a potentially hazardous situation which, if not avoided, MAY result in minor or moderate injury. It may also be used to alert against unsafe practices.
Note	Gives tips that help.

1.2 General Safety

- Read these instructions completely before installation and use.
- Provide them to any technician used to install, maintain, or repair this device and provide them with the device if it is ever given or sold to a third party.
- Install and use this gate opener only in accordance with these instructions and all applicable local and national laws and regulations. Adding instructional or warning signage may be necessary in your area.
- **DO NOT** install this device in any area prone to flooding or in locations exposed to flammable or explosive fumes.
- Always aim to minimize public exposure to potential hazards such as pinch points. Failure to do so may result in serious property damage and severe personal injury.
- **NEVER** allow children to play on or around this device or its attached gate. Keep controls away from children and out of their reach at all times and warn them of the gate's danger.
- All provided components of this device are weatherproofed to withstand normal rain. Ensure adequate insulation and protection of all electrical connections and never direct pressurized water against any part of this device.
- Keep your gate well maintained and its hinges free of grime and debris. Periodically confirm that it runs smoothly under manual operation.
- **DO NOT** use if any component is missing, loose, worn, or damaged. Tighten, repair, or replace problematic parts before further use. Only replace components with identical parts and always fully replace damaged electrical cords.
- Become familiar with potential entrapment zones as shown below and avoid these areas while the gate is on.

- The control box is so designed that a lock can be attached to keep the box securely closed. **MIND THAT THE BUCKLES ALONE ON THE CONTROL BOX CANNOT PROTECT IT FROM UNAUTHORIZED ACCESS. USE A PADLOCK TO LOCK IT UP.**
- Maintain the gate and the gate opener system to make sure that the gate continues to swing freely and is level throughout the entire swing path. The gate hinges should be lubricated regularly, the condition of the battery checked every few months, and all connections checked no less than an annual basis.
- If you sell the gate opener system or your property with a system installed, please provide these instructions to the new owners.
- Do not attempt to “race the gate” by driving through the gate while it is opening or closing. This is extremely dangerous and can cause damage to your vehicle, gate, AND the gate opener system.

1.3 Designated Use

- Only use the device for its intended purpose, opening and closing a single or double-leafed gate for vehicular traffic.
- Install and use this gate opener only on firm, level ground. Install and use this device so that its motor and other hazardous components are not in public areas and are protected as much as possible from unauthorized access and use. There should be adequate clearance between your gate and any nearby structures to prevent any possibility of pinching or crushing hazards during use. If this is impossible, the area should be guarded as well as possible and warnings placed nearby.
- Pedestrians should be provided with a separate access point far enough away to ensure they never come into contact with the moving vehicular gate.
- **NEVER** pair a remote control for this device with any other control board. Never attempt to operate this device with two or more remotes or control devices at the same time.
- **ONLY** install fixed controls for the gate where they cannot be reached over, under, around, or through the gate. They should also be far enough away that operators.

1.4 Electrical Safety

- **ONLY** allow trained technicians to install and repair this device and its electrical connections.
- Disconnect all power from electronic components during installation and maintenance except as instructed for safely testing functionality.
- **ONLY** use conductors of sufficient gauge for the expected electrical load of this device.

The wiring connections should be able to withstand rain and other weather. It is recommended that the power cable run underground near the gate inside a PVC pipe.

1.5 Gate Requirements

- The gate must be plumb, level, and swing freely on its hinges.
- The gate must weigh under 993 lb. (450 kg) and measure within 11.5 ft. (3.5 m)
- Wheels must **NOT** be attached to the gate.
- The gate must move throughout its arcs without binding or dragging on the ground.
- Note that a gate over 250 lbs. should have ball bearing hinges with grease fittings.
- The gate post should be secured in the ground with concrete so it will minimize twist or flex when the opener is activated.
- Make sure there is a stable area for mounting the gate bracket (this may require the addition of a horizontal or vertical cross member).

For other requirements on the construction of vehicular gates, contact ASTM at 610-832-9585 or www.Astm.org.

1.6 Entrapment Countermeasures

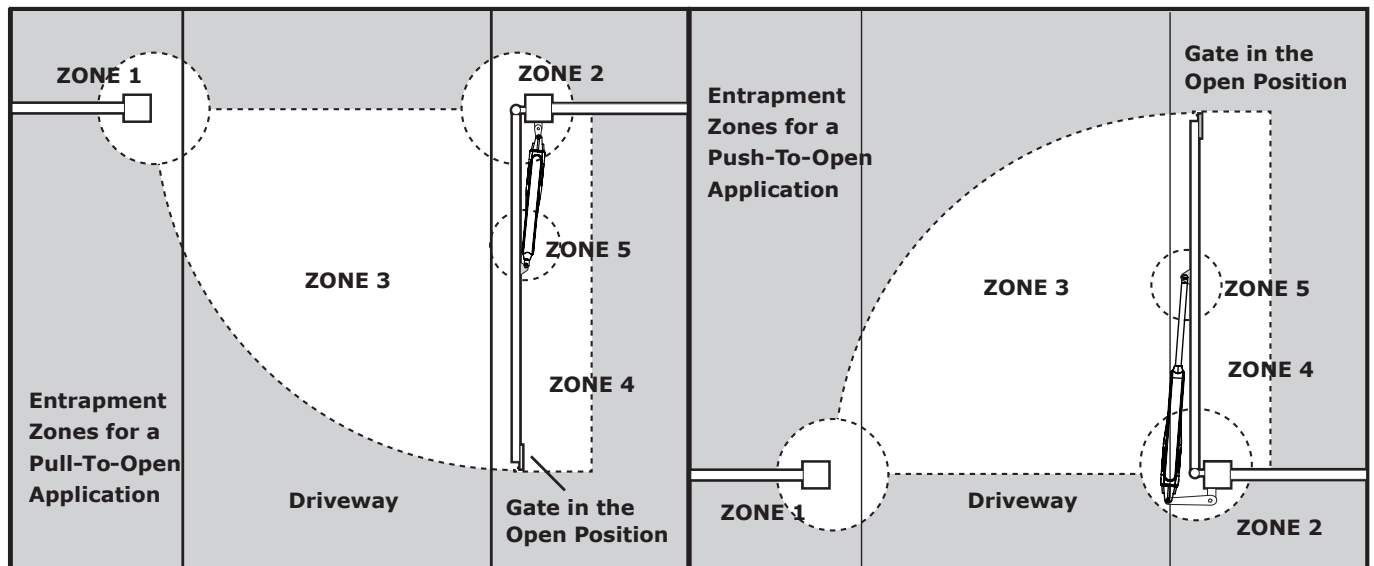

These are the possible entrapment or pinching zones.



Use the countermeasures listed below to preempt the potential accidents.





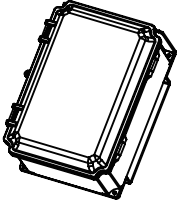
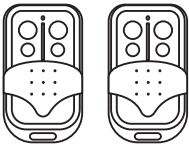
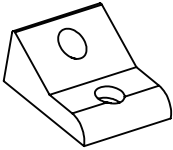
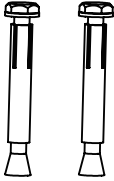
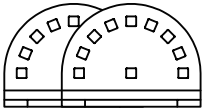
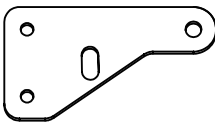

Entrapment Zones	Countermeasures
1	Use warning signs (not included) to warn users of the use of an automated gate and its dangers.
2	
3	Stay clear of this zone while the gate is moving.
4	Stay clear of this zone while the gate is moving.
5	Stay clear of this zone while the gate is moving.

2 ABOUT THE PRODUCT

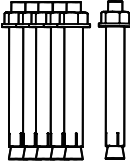
2.1 Package List

First Actuator Parts

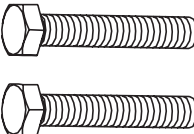
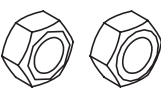



Parts	Items	Name	Qty.
Rear Mount Hardware		Front Bracket Wrench	1
		Front Bracket	1
Control Hardware		Control Box	1
		Remote Controls	2
Gate Hardware		Gate Stop Block	1
		M8×60 Expansion Bolts	2
Rear Mount Hardware		Rear Brackets	2
		Rear Bracket Plate	1



Parts	Items	Name	Qty.
Rear Mount Hardware		*M10×150 mm Expansion Bolts	6
		Rear Bracket Bolts and Nuts	3
		Rear Mounting Bolt	1
		Rear Mounting Nut	1
		M8×70 Bolts	2
		M8 Bolts	2
		M8 Spring Washers	2

 **Caution**

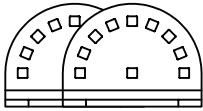
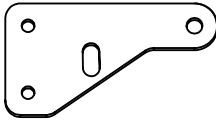
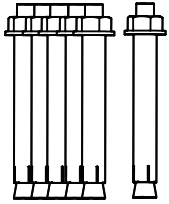
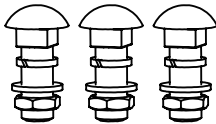
*These expansion bolts are for mounting the rear brackets and plates to masonry posts. For posts made of wood or other material, use solid fasteners of the same gauge, but **DO NOT** use the expansion bolts.

Second Actuator Parts

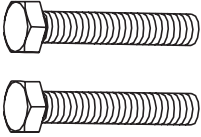
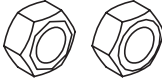
Parts	Items	Name	Qty.
Rear Mount Hardware		Front Bracket Wrench	1
		Front Bracket	1
Rear Mount Hardware		Rear Brackets	2
		Rear Bracket Plate	1
		*M10×150 mm Expansion Bolts	6
		Rear Bracket Bolts and Nuts	3
		Rear Mounting Bolt	1

Parts	Items	Name	Qty.
Rear Mount Hardware		Rear Mounting Nut	1
		M8×70 Bolts	2
		M8 Nuts	2
		M8 Spring Washers	2

 **Caution**

*These expansion bolts are for mounting the rear brackets and plates to masonry posts. For posts made of wood or other material, use solid fasteners of the same gauge, but **DO NOT** use the expansion bolts.

Power Source Parts

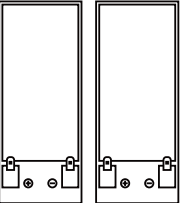
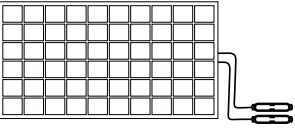
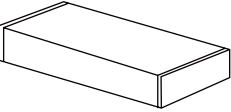
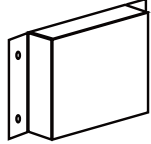
Items	Name	Qty.
	8 Ah Batteries	2
	Solar Panel	1
	Solar Panel Installation Kit	1
	Solar Panel Controller	1

2.2 Specifications

Input Power	12 V DC	
Rated Power (ea.)	0.37 hp	8 W
Duty Cycle	S2 20 min.	
Max. Gate Weight	900 lb. × 2	400 kg × 2
Max. Gate Speed	5 fpm	2.5 cm/s
Max. Gate Length	20 ft.	6 m
Min. Temperature	-4°F	-20°C
Max. Temperature	122°F	50°C
Weatherproofing	IP55	
Max. Remotes	120	
Remote Radius	164 ft.	50 m

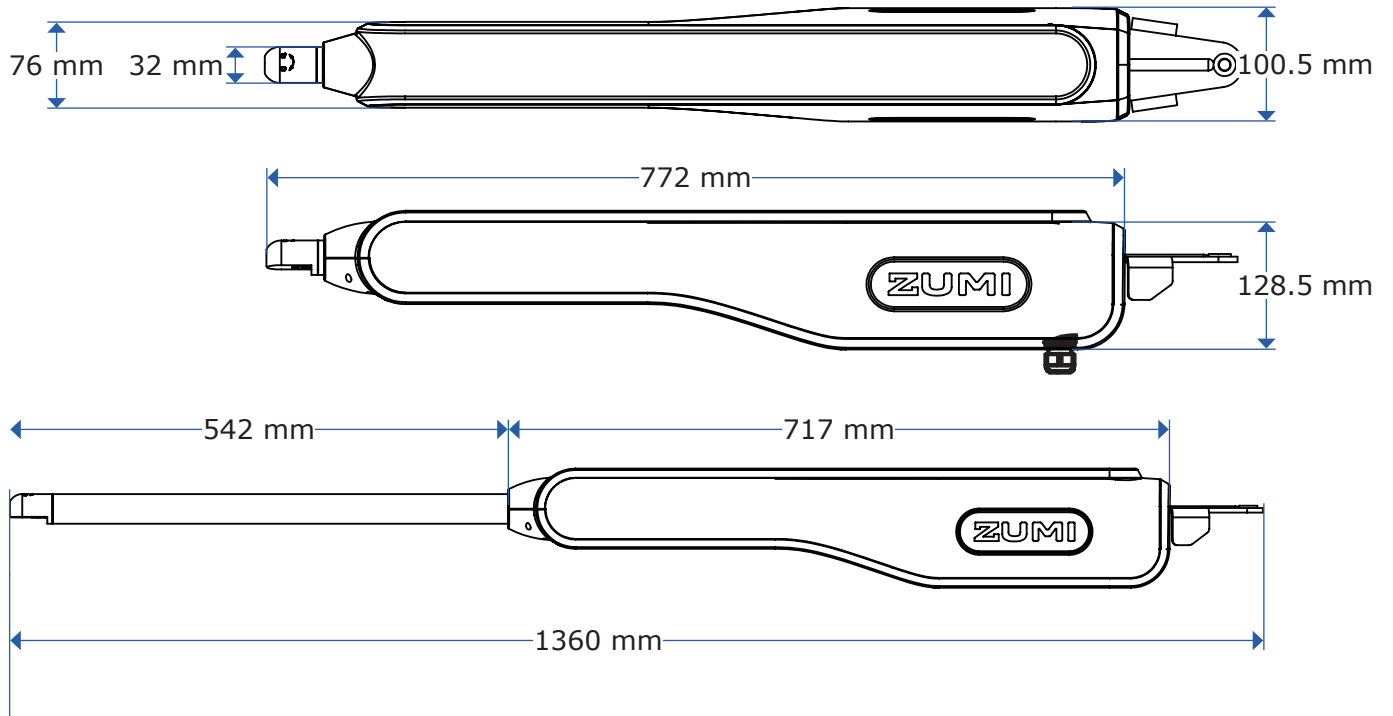

3 INSTALLATION

3.1 Typical Installation Overview

Refer to the diagrams below for the position of the actuators relative to the gate.

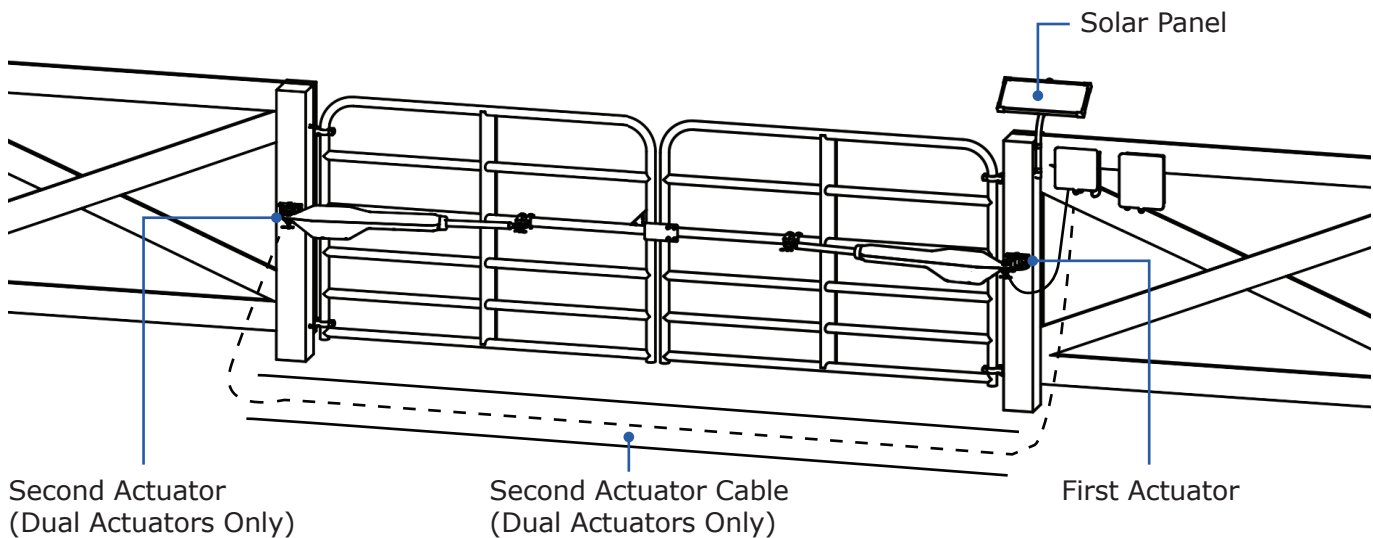

Caution

Note that the demonstration above is a pull-to-open (PLO) setup. The specific setup for your gate depends on the specs of your gate. See the installation below for the different installation procedures.

Note that the actuators can be installed for two setups: push-to-open (PSO) and pull-to-open (PLO). Use the setup that will suit your needs.

PSO Setup

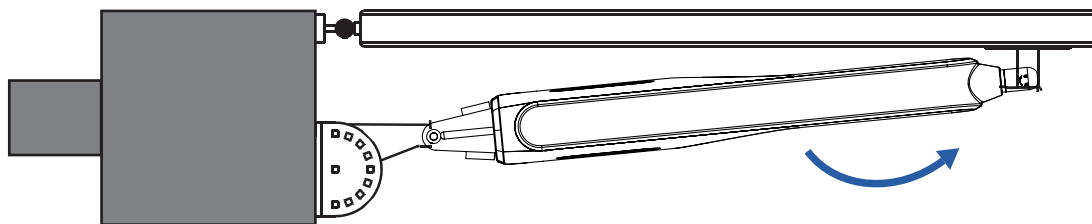

PLO Setup

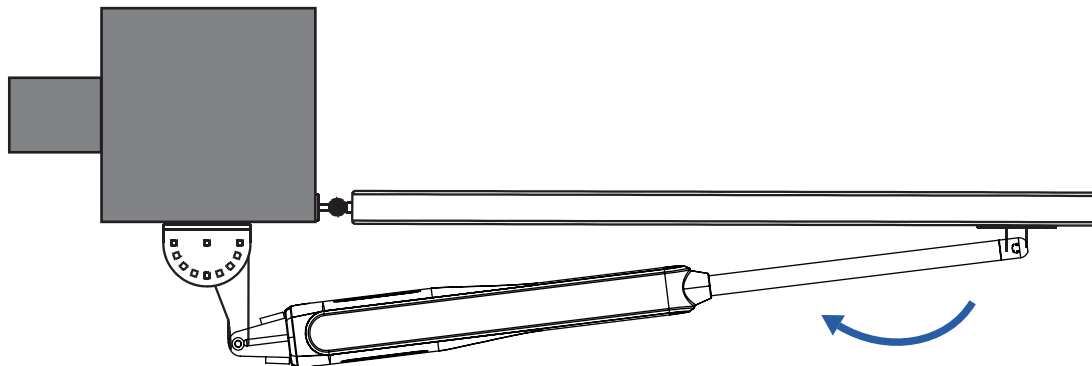

Warning

- For either setup, clear any obstructions that may come into contact with the moving gate leaves or the actuators.
- Note that the rear bracket installation for the PSO and PLO setups are different, and make sure you use the same installation for the same setup.

3.2 Pre-Installation Check

Check that the gate:

- Is plumb, level, and swing freely on its hinges.
- *Weights and measures within the range in the chart below.
- Has no wheels attached.
- Moves throughout its arcs without binding or dragging on the ground.
- Has ball bearing hinges with grease fittings.
- Has concrete-reinforced foundation so it will minimize twist or flex when the opener is activated.
- Has a stable area for mounting the gate bracket (this may require the addition of a horizontal or vertical cross member)

Caution

- Use your levels to check whether the gate leaves are level.
- If the gate leaves prove to be unlevel or the hinges to be off-center or stuck, fix the problem(s) before installing this automatic gate system.
- For wooden posts that do not have a steadfast foundation, reinforce their bases with concrete. Otherwise, with the system installed and running, the gate would fall, causing property damage and personal injuries.

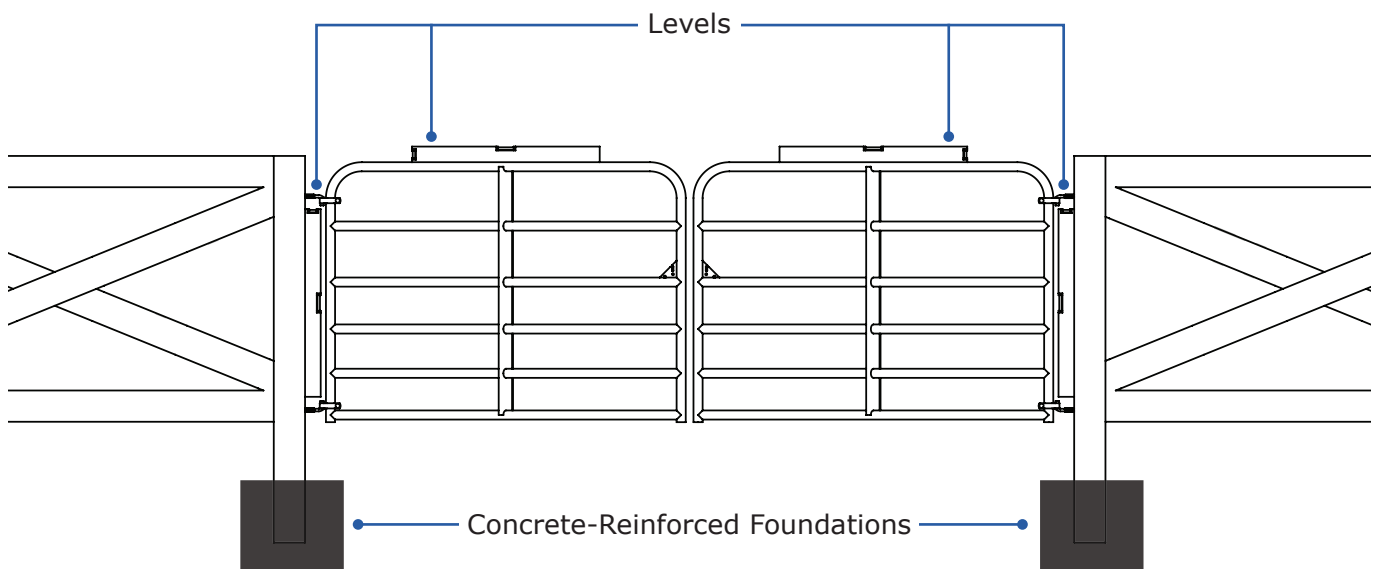

MAX	5 ft.	6 ft.	8 ft.	10 ft.	12 ft.	14 ft.	16 ft.	18 ft.	20 ft.
900 lbs.									
800 lbs.									
700 lbs.									
600 lbs.									
500 lbs.									
400 lbs.									
350 lbs.									
300 lbs.									
250 lbs.									

3.3 Push-to-Open Installation (PSO)

3.3.1 Locating the Center Line

Tools Needed but Not Included

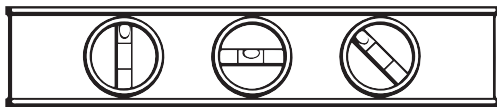

Level

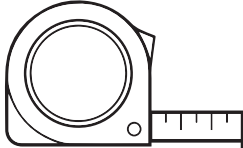

Tape Measure

Use your level and tape measure to find out the center line of your gate leaves and posts.

Note

This centerline will be used for mounting the post bracket.

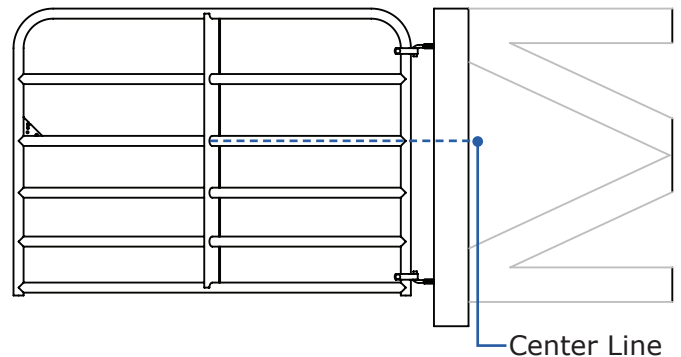

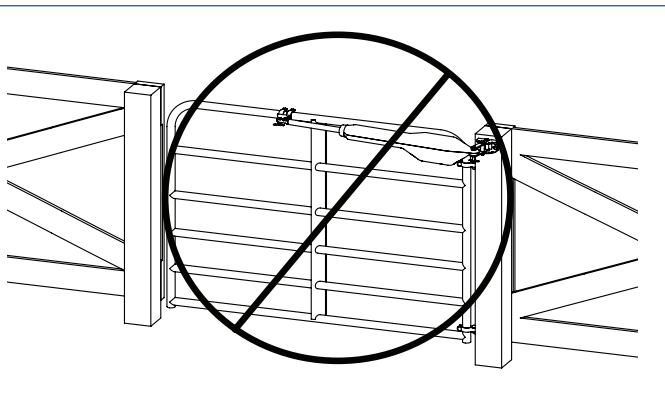
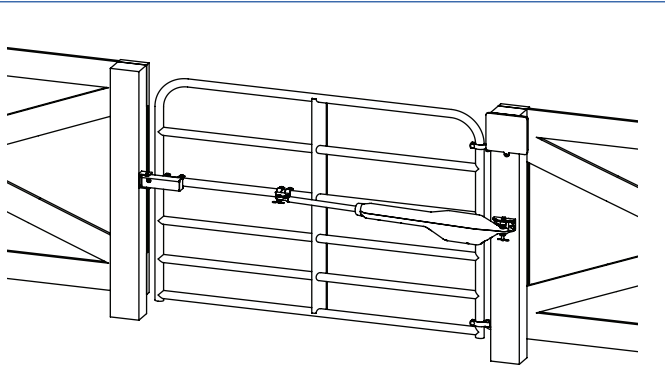
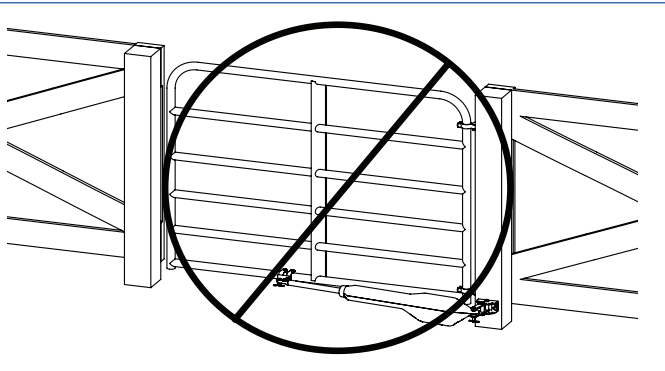
<p>Top Mounting</p>	<p>Not recommended—could cause the gate to be flexed or twisted.</p>	
<p>Center Line Mounting</p>	<p>Recommended—allows even force to be applied to the gate.</p>	
<p>Bottom Mounting</p>	<p>Not recommended for the same reason for the top mounting.</p>	

3.3.2 Post Bracket Pre-Assembly and Location

Tools Needed but Not Included

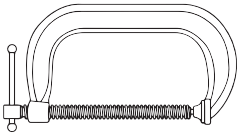

Clamp



Adjustable Wrench × 1



Cordless/Corded Drill

OR

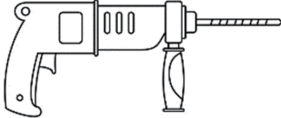

Hammer Drill



12 mm Regular or Masonry Drill Bit

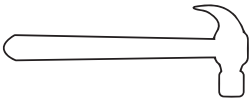

Regular Hammer

Hardware Needed

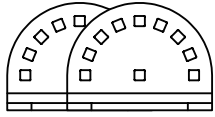

Rear Brackets × 2

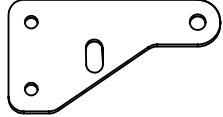

Rear Bracket Plate

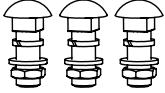

Rear Bracket Bolts and Nuts × 3

1. Assemble the post bracket the way shown.

 **Caution**
Do not fully tighten the bolt sets yet.

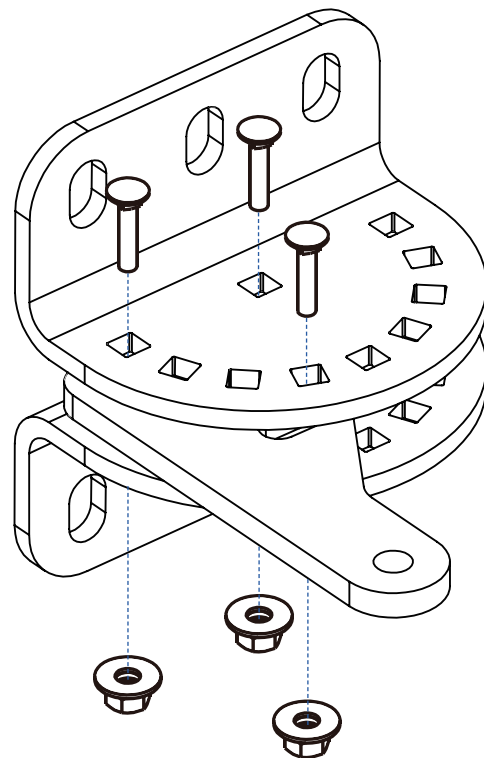

2. Clamp the pre-assembled post bracket to the gate post, making sure the rear bracket plate superimposes the center line.

Note

- For wooden, cylindrical posts, notch the posts per the dimensions of the post bracket.
- For posts made of materials other than wood, make sure they provide a flat interface (5 in. by 5 in.) with the post bracket.

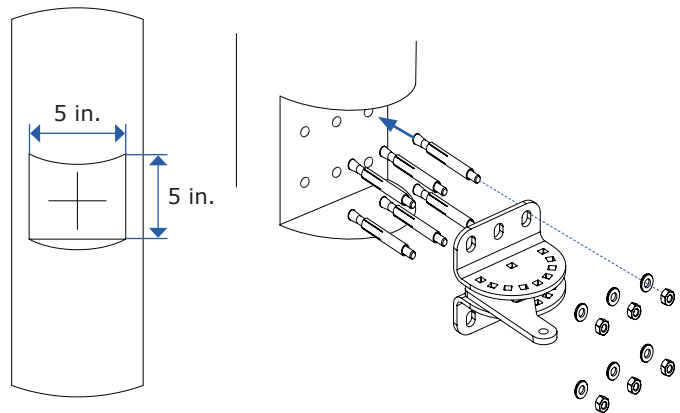
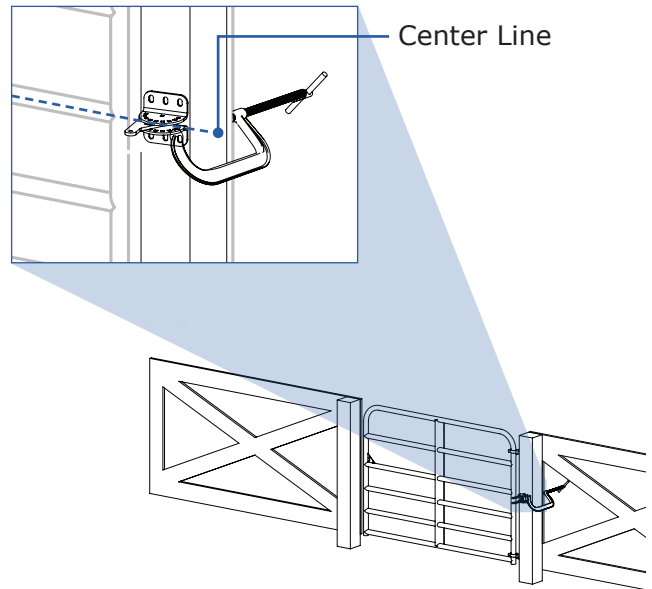

3. Adjust the position of the rear bracket, making sure the mounting hole on the rear bracket plate is at least 5.4 in. away from the bar/surface, where the actuator is going to be mounted.

4. Once the position of the rear bracket has been determined, fully tighten the nuts on the bracket.

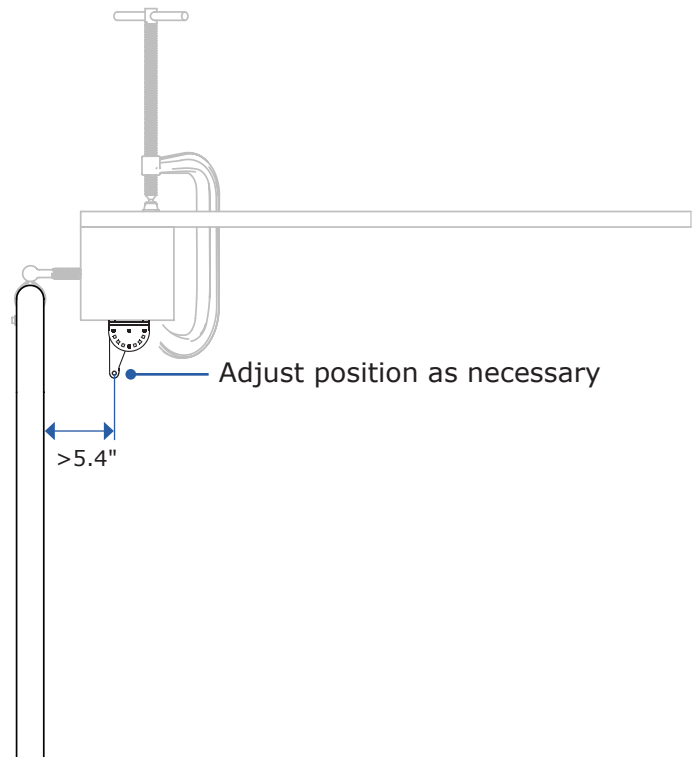

3.3.3 Mounting the Post Bracket

Tools Needed but Not Included

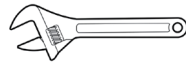

Adjustable Wrench × 1



Cordless/Corded Drill

OR

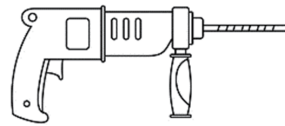

Hammer Drill



12 mm Regular or Masonry Drill Bit

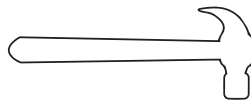

Regular Hammer

Hardware Needed

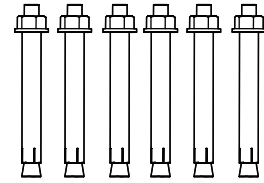

M10×150 mm Expansion Bolts × 6

Note

- The provided expansion bolts are for mounting on masonry posts. For posts made of other materials, use correct fasteners.
- The provided bolts are 150 mm in length, which are meant for anchoring into your posts. If they are so long as to impale your post, use alternatives that won't.

Mounting on wood, however, requires full penetration of the posts; make sure you have fasteners of the correct length and type.

1. With the rear bracket clamped to the gate post, mark where the holes should be for the expansion bolts.

Warning

Follow all the protocols concerning the safe use of electric drills or hammer drills.

2. Drill each hole where the mark was made.
3. With the nuts on the expansion bolts unmoved, hammer the expansion bolts into the drilled holes.
4. Remove the nuts.
5. Bolt the rear bracket to the gate post using the correct fasteners.

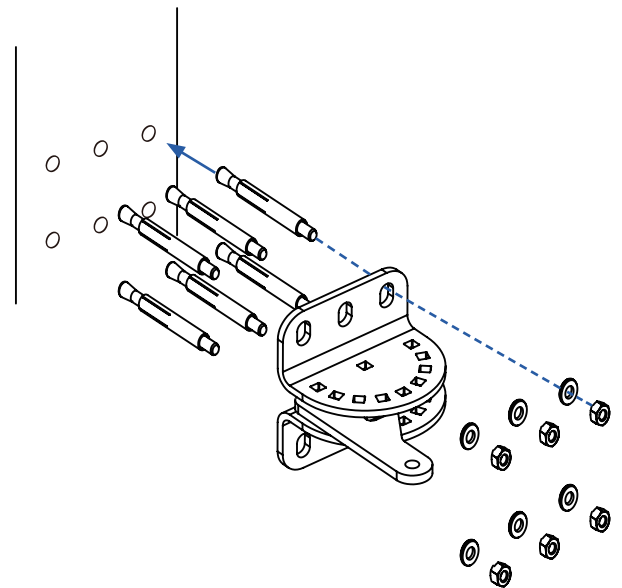

3.3.4 Connecting the Actuator

Tools Needed but Not Included

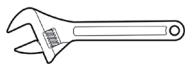

Adjustable Wrench × 1

Hardware Needed

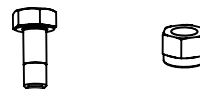
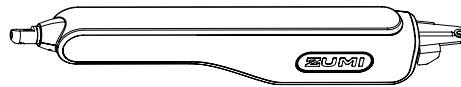

Rear Mounting Bolt & Nut

Connect the actuator to the mounted rear bracket using a pair of rear mounting bolts and nut.

Warning

DO NOT leave the actuator hanging in the air while working on the following installation steps; hook it to the gate bars or seek help to hold it.

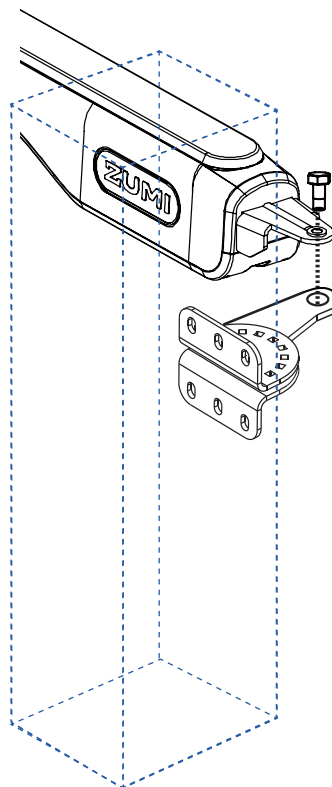

3.3.5 Mounting the Control Box

Tools Needed but Not Included

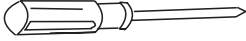

Phillips Screwdriver



Cordless/Corded Drill

OR

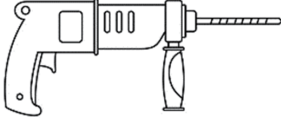

Hammer Drill



12 mm Regular or Masonry Drill Bit

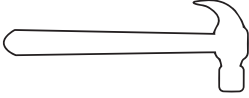

Regular Hammer

Hardware Needed

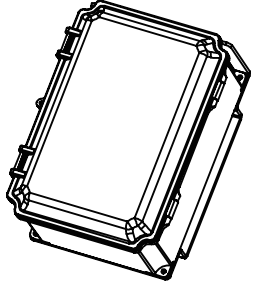

Control Box

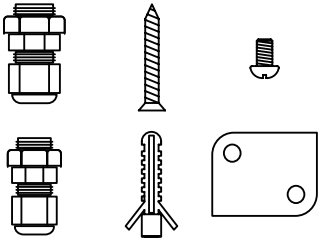

Preparing the Control Box

1. Release the latches on the control box and remove the circuit board and battery (if included).
2. From inside the control box, remove the knockouts with any tool appropriate for the job.

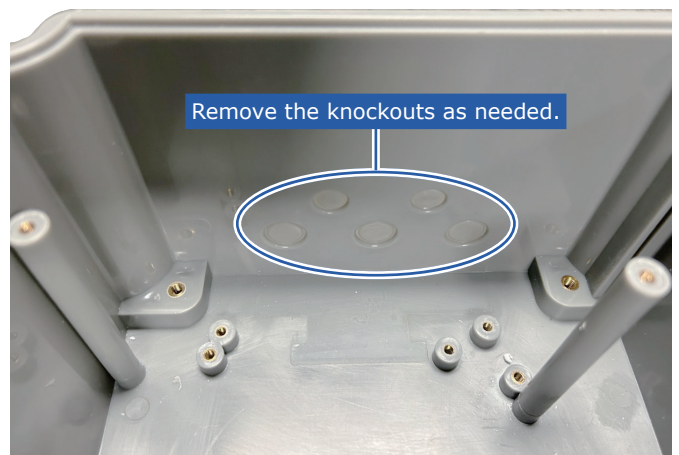

3. Remove the nut on any of the cable glands, insert it into the newly created hole, and fasten it using its removed nut.
4. Install the remaining cable glands in the same way.

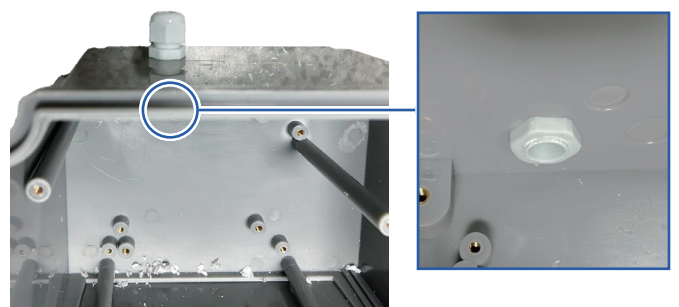

Mounting

Warning

- Mount the control box a minimum of 3 feet above the ground to keep dirt and water from damaging the control board and within 4 feet of the actuator arms in order for the operator cable to reach the control box.
- Mounting the box upside down WILL risk short-circuiting the circuit board. Make sure the cable glands will face the ground.
- The control box has a seal that can protect its insides from mild precipitation. For maximum safety, install a shade for it.
- Once the whole system is up and running, lock the control box's lid with a padlock.

1. Making sure no battery is inside, flip the control box.
2. Slide any mounting bracket to complete the corner of the box.
3. Fasten the bracket to the box using the mounting bolt.
4. Repeat for the remaining box corners.
5. Press the assembled control box and its brackets against the surface on which it will be mounted.
6. Mark the surface through the remaining holes on the mounting brackets.
7. Remove the box and drill a hole where the mark was made.
8. Attach the control box using the anchor bolts.



3.3.6 Wiring the Actuator

Warning

- For optimal safety, we recommend the wiring be done by a certified electrician.
- (Optional) If your models have two actuators, protect the cable of the one further from the control box.
- If you have only one actuator and your door is single-leafed, connect the wires of your actuator to **MOTOR 2**.
- For models that come with no battery and solar panel, we recommend using a transformer able to handle the electrical draw of the circuit board.
- For a longer battery service life and a pleasant experience of this automatic gate opening system, we recommend using the provided battery in conjunction with the solar panel, which should maintain the battery's optimal performance and preclude the possibility of an over-discharged battery.
- The LCD will show "Lb" when the battery is running out. Charge it use a compatible charger.
- Whatever the model of your gate opener is, be it single motor or dual motor, we recommend that you use a solar panel as a power supplement for the battery. If you must have to solely rely on the batteries, keep a regular check on the LCD.

Tools Needed but Not Included

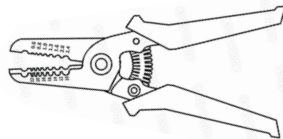

Wire Stripper

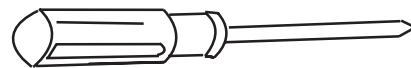

Phillips Screwdriver

Battery

1. Strip the wire ends to expose wire long enough to wrap around the bolt on the terminal blocks.
2. Connect the **RED** wire of the actuator to the right terminal of **MOTOR 2** on the circuit as shown.
3. Connect the **BLUE** wire to the left terminal of **MOTOR 2**.

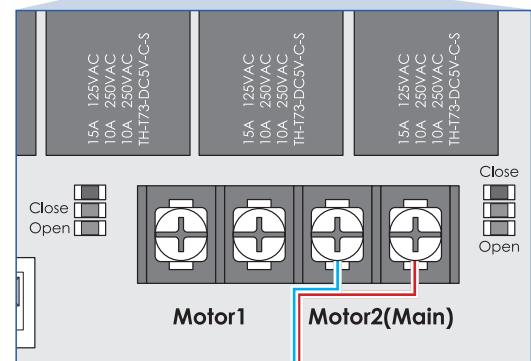
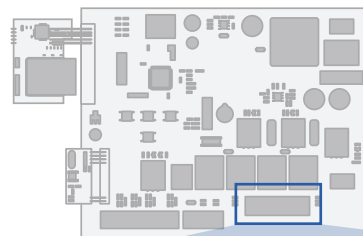

4. Set two batteries into their compartment over the circuit board.

If their wiring has become loose, tighten the connection(s) using pliers.

5. Insert the battery plug into the terminal on the circuit board as shown.

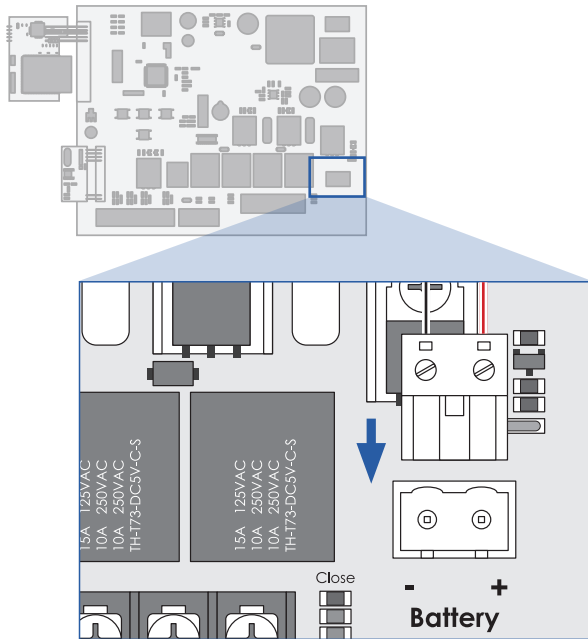

Solar Panel

Warning

- As before, we recommend the wiring be done by a certified electrician.
- For maximum compatibility between and functionality of the devices, we recommend that you use authentic parts from ZUMI. For your convenience, the SKU for the solar panel is AGO-ZUMI-04.
- **DO NOT** connect the electrodes of the same battery or let their wires to accidentally contact, as this **WILL FRY THE BATTERY**.
- This steps below are for connection with a ZUMI solar controller. For connecting one of a different brand, refer to its manual.
- **DO NOT** connect the assembled solar panel and battery to the POWER terminal on the circuit board. Use the BATTERY board.

Wiring

Wire your solar panel as shown.

1. Connect the battery output (**RED**) of the solar panel to the **RED** wire of the battery set.
2. Connect the battery input (**BLACK**) of the solar panel to the **BLACK wire of the** battery set.
3. Insert the load output (**RED**) to the positive terminal on the circuit board. Fasten the screw.
4. Insert the load input (**BLACK**) to the negative terminal on the circuit board. Fasten the screw.
5. When finished with connecting, check that **Charge** indicator is on. If it is not, reconnect using the steps above.

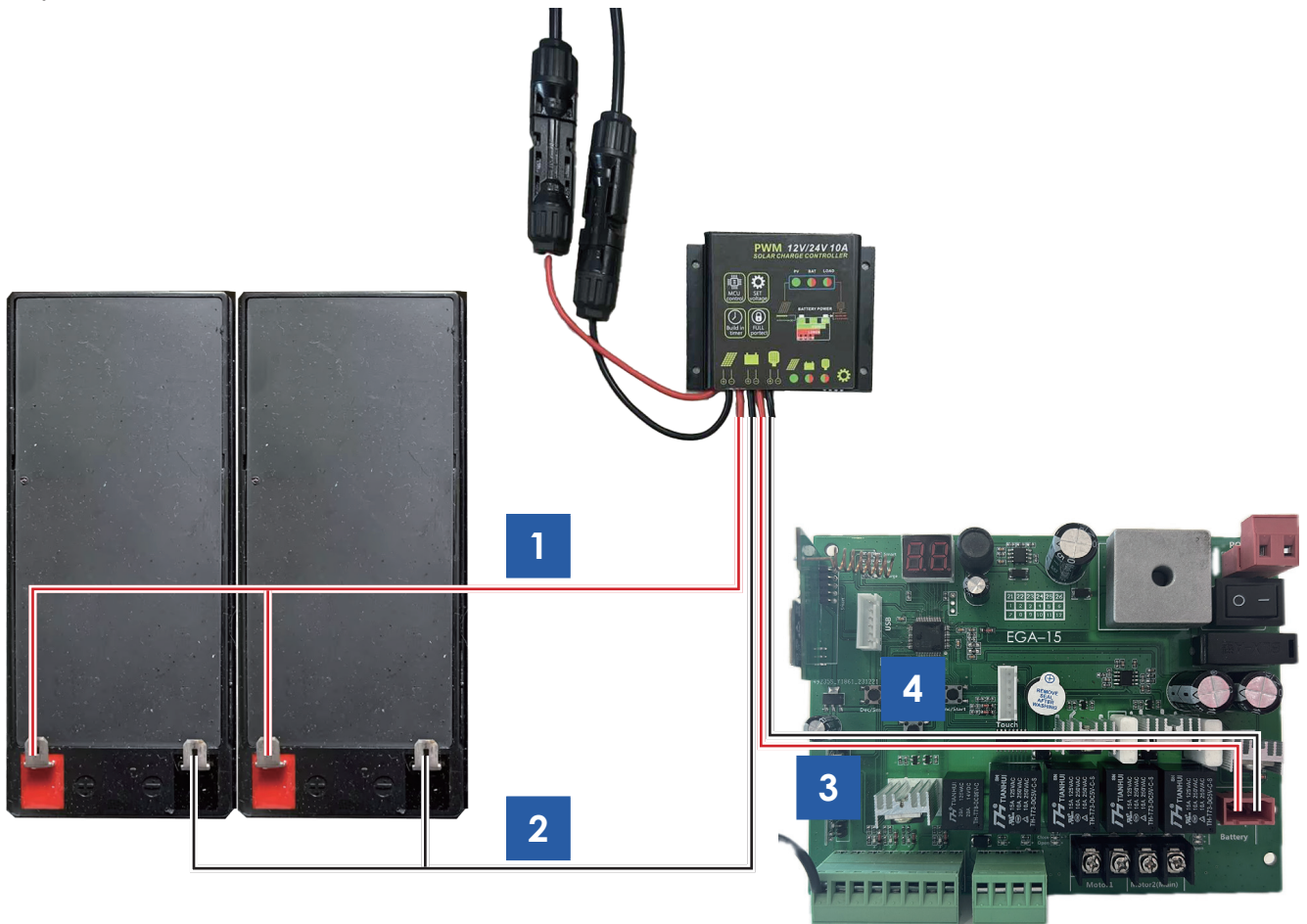

Solar Chart

Note

- The table and map illustrate the maximum number of gate cycles to expect per day in a particular area when using from 5 to 30 watts of solar charging power before the batteries deplete.
- The figures shown are for winter (minimum sunlight) and do not account for the use of any accessory items.

No. of Solar Panel	Solar Panel Ratings	Zone 1	Zone 2	Zone 3
1	12V Solar Panel (10W)	4	6	8
	12V Solar Panel (20W)	8	12	15
	12V Solar Panel (30W)*	12	18	23
2	12V Solar Panel (10W)	8	12	15
	12V Solar Panel (20W)	16	24	30
	12V Solar Panel (30W)*	24	36	46

*For maximum compatibility between and functionality of the devices, we recommend that you use authentic parts from ZUMI. For your convenience, the SKU for the solar panel is AGO-ZUMI-04(ZSP1).

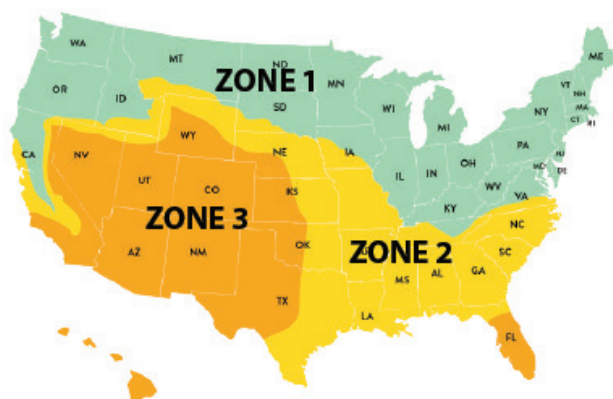

Transformer

Warning

- If a transformer is to be used to power the circuit board and the actuator(s), make sure you connect it to the terminal marked **POWER** on the circuit board.
- **NEVER USE YOUR TRANSFORMER, SOLAR PANEL AND BATTERIES AND THE SAME TIME, AS THE CIRCUIT BOARD WILL BE INSTANTLY FRIED.**

3.3.7 Mounting the Front Bracket

As mentioned before, the front and rear brackets should be mounted on the center line of your gate. However, such a line might be imaginary if your gate does not have a horizontal bar that seats perfectly where the centerline is or if your gate poses a specific challenge that will make mounting the front bracket on the centerline impossible.

To solve these, see below.

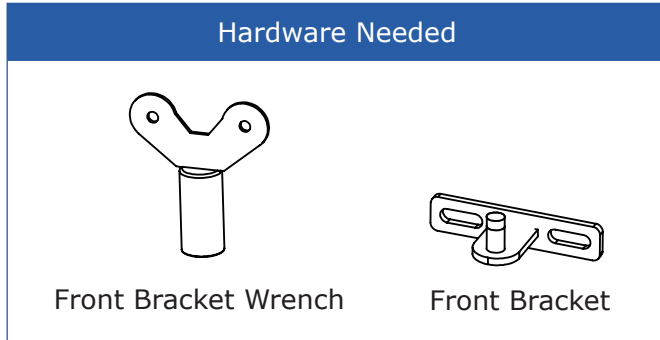



Preparing the Gate

Use the front bracket wrench to loosen the square bolt at the tip of actuator.

Note
The U-shaped brackets and the reinforcement panel are not included as accessories. Buy ones that fit.

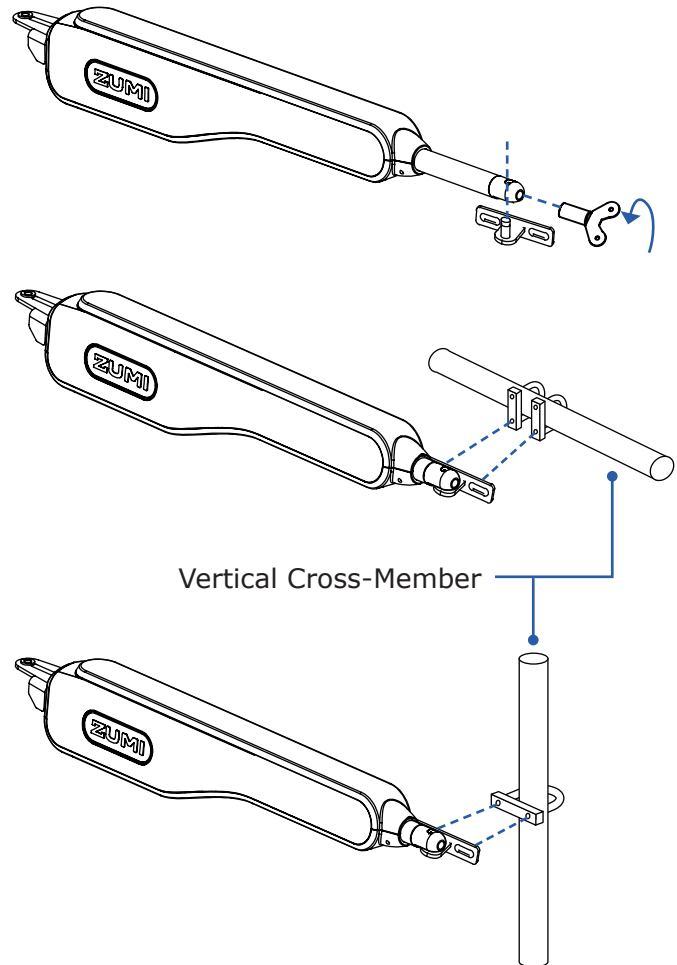
1. Insert the pivot of the front bracket in to the hole at the actuator tip.
2. Lock the square bolt using the same wrench until the bolt retains the front bracket but is not pressed against each other.
3. Close your gate and press front bracket tight against the gate panel/bar.
4. Use the following steps to prepare your gate panel or bar.
 - For gates that do not have a horizontal bar at the center line, attach a horizontal or vertical cross-member (not included) for reinforced mounting of the front bracket.



 **Warning**
WE RECOMMEND THIS BE DONE BY PROFESSIONALS.

As shown, the front bracket can be attached to the base of the muffler clamp (not included).

- Similarly, if your gate consists of multiple horizontal or vertical bars, using muffler clamps to attach the front bracket will provide a solid connection.

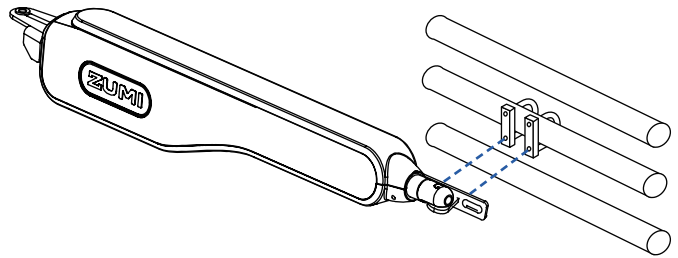

- If a single bar of your gate is not robust enough to take the force of the actuator, reinforce the bars with a metal sheet.

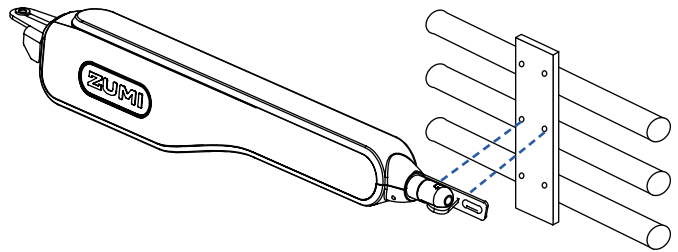

Warning

Alternatively, holes can be drilled into the horizontal/vertical bar/cross-member. This kind of work, however, requires professionalism and expertise. **WE RECOMMEND THIS BE DONE BY PROFESSIONALS.**

- For gates that have panels, do the same to ensure that the gate panel can take the force of the actuator.

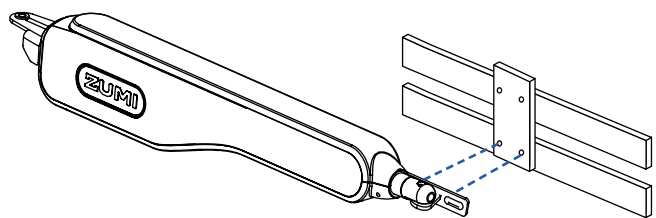

Mounting

Tools Needed but Not Included

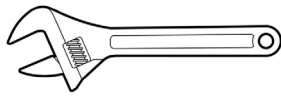

Adjustable Wrench × 1

Hardware Needed

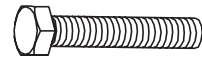
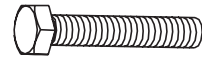

M8×70 Bolts × 2

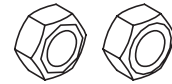

M8 Nuts* × 2



M8 Spring Washers × 2

1. Loosely attach the front bracket to your gate using the holes you created on the gate bar correct fasteners.

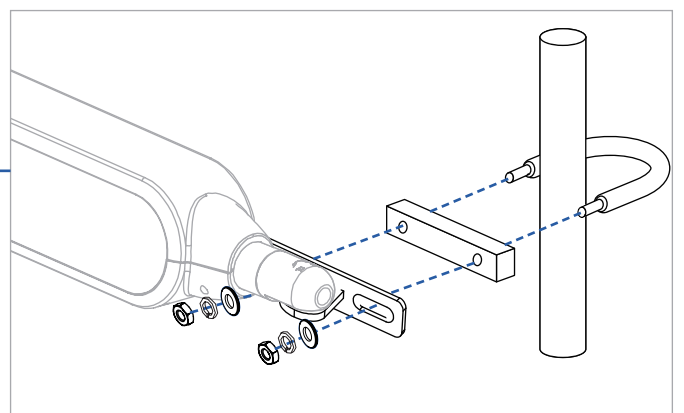
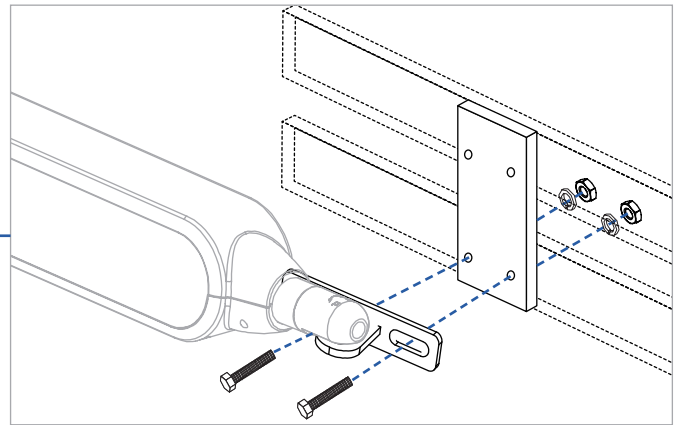
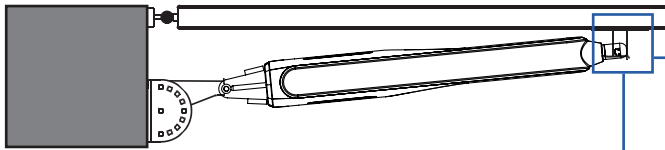

2. Open the control box and toggle the rocker switch to **-**.

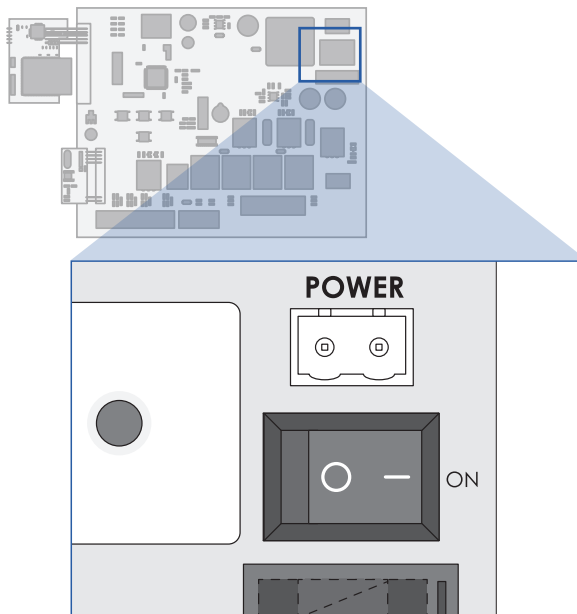

3. Press either of the top two buttons on either of the provided remote controls to extend the actuator's arm, opening the gate.
4. Press the other button of the top two buttons to fully close the gate.
5. Check that the actuator is so positioned that it will open and close your gate leaf to the desired extent. If necessary, adjust the position of the front and rear brackets.
6. When finished with checking the positions of those brackets, fully tighten the nuts of the front bracket.

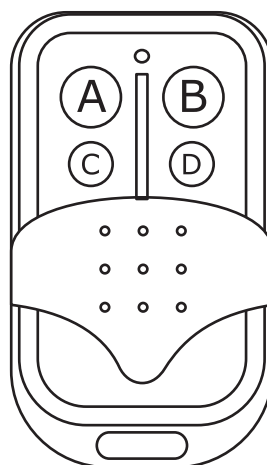

3.3.8 Installing the Limit Stop

Tools Needed but Not Included

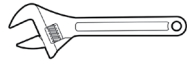

Adjustable Wrench × 1



Cordless/Corded Drill

OR

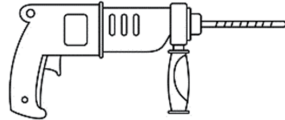

Hammer Drill



10 mm Regular or Masonry Drill Bit

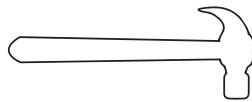

Regular Hammer

Hardware Needed

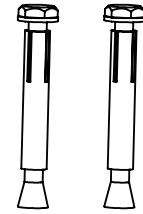

M8x60 Expansion Bolts × 2

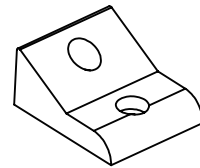

Limit Stop

1. Using your hammer drill or regular drill, drill two holes at where the gate stops.

Caution

- Note that the hole **MUST** be inside your property.
- If the ground about where the gate leaves meet is not concrete, make it so. Anchoring the limit stop to soil would render it useless.
- If the limit stop is too short for the gate-ground clearance, use a higher one (not included) but **DO NOT** skip on this.

2. With the nuts unmoved, hammer the two expansion bolts into the holes you drilled.
3. Bolt the limit stop to the expansion bolt studs.

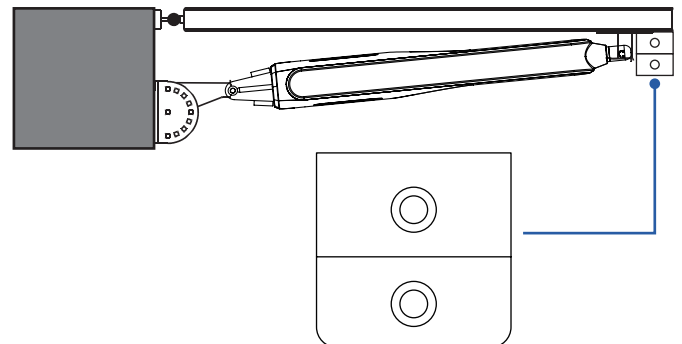

3.3.9 Installing a Second Actuator

If you have purchased a dual-actuator model, install the other actuator following the same steps as in § **3.3.1–3.3.9**.

 **Warning**

Wire the second actuator to the vacant motor terminals the same way as for actuator 1(Main).

3.3.10 Programming

Circuit Board

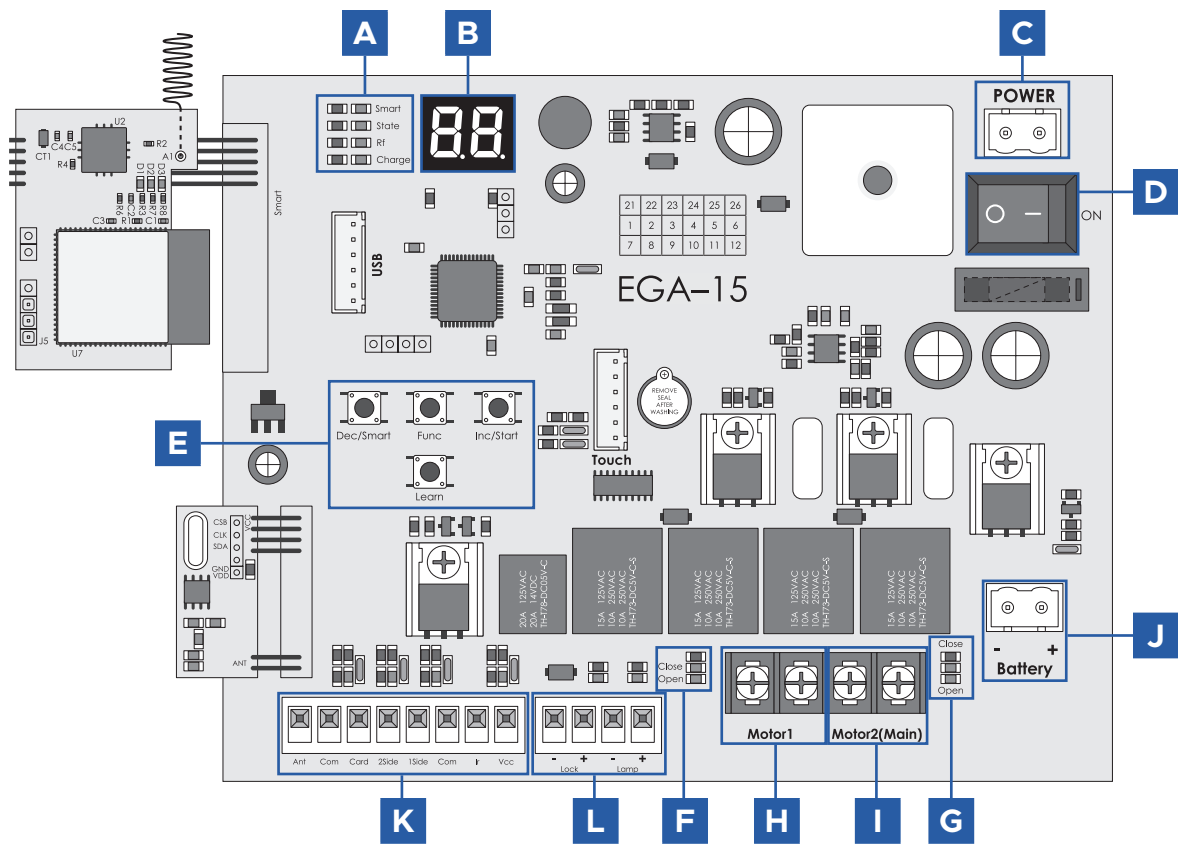

A	Indicator lights	Smart (blue)	Indicates the working status of the smart module.
		State (red)	<ul style="list-style-type: none"> Lights up and stays glowing if the system has been initialized normally. Flash once a second during gate closing countdown.
		Rf (blue)	<ul style="list-style-type: none"> Indicates the pairing and unpairing status of a remote control. Starts flashing upon receiving a signal emitted from a remote of the same brand as the circuit board, independent of whether such remote has been paired or not before.
		Charge (red)	<ul style="list-style-type: none"> Lights up and stays on when the battery is being charged. Lights up when the battery is not being charged and when the voltage of the battery is below $13.5V \pm 0.5V$.
B	Display	Shows 20 parameters and 10 codes. For details, see Display Parameters and Message Codes on Page 43.	
C	12 V Power Input (DC)	Connects to a 12V DC power supply. Remove the battery plug if this input is to be used.	
D	Main Power Switch	Turns the whole system on and off.	

E	Function Buttons	Dec / Smart	<ul style="list-style-type: none"> Decreases the value of a parameter in a menu. Toggles the parameters in the descending order. 	
		Func	<ul style="list-style-type: none"> Holding it for 3 seconds and releasing enters parameters menus. Pressing it once saves the change to a parameter. 	
		Inc/ Start	<ul style="list-style-type: none"> Increases the value of a parameter in a menu. Toggles the parameters in the ascending order. 	
		Learn	<ul style="list-style-type: none"> When in the parameter menus, pressing it once exits a parameter value and dims the display. When in the main menu, pressing it once enters the remote pairing. Holding it for 6 seconds purges all the paired remotes. 	
F	Motor 1 Indicator Lights	<ul style="list-style-type: none"> Glow blue when the gate is opening. Glow red when the gate is closing. 		
G	Motor 2 Indicator Lights	<ul style="list-style-type: none"> Glow blue when the gate is opening. Glow red when the gate is closing. 		
H	Motor 1 Terminals	Connects to actuator 1.		
I	Motor 2 Terminals	Connects to actuator 2. Caution: If only one actuator is to be used, connect it to the terminals of motor 2.		
J	12 V Battery Input	Connects to the two provided 12V batteries or equivalents.		
K	Terminal Block 1	Ant	Connects to the antenna.	
		Com	Common ground for terminal block 1.	
		Card	Connects to a swipe-card control.	
		2Side	Connects to a keypad/single button key.	
		1Side	Connects to a keypad/single button key.	
		Com	Common ground for terminal block 1.	
		Ir	Connects to infrared sensors.	
L	Terminal Block 2	Lock	-	Connects to the negative pole of the lock.
			+	Connects to the power input of an electric lock. The voltage changes as the input power changes.
		Lamp	-	Connects to the negative pole of the lamp.
			+	Connects to the power input of an alarm lamp. The voltage changes as the input power changes.

Initial Setup

Testing the One-Button Mode

Warning

- Run this test before actually using this automatic gate system.
- Check that the actuator opens and closes the gate in the right directions following the signals of the provided remote.
- Clear any obstruction that is or might come into the moving path of the gate and actuators before testing.

The two remotes have been pre-paired at the factory. Both have the same functions. Use either to test the one-button mode. Note that button A and button B control different actuators; button C is disabled and button D nullifies auto-closing.

Press	Button A	Actuator
1 st	Opens the gate.	2 nd
2 nd	Stops the opening gate.	2 nd
3 rd	Closes the gate.	2 nd
4 th	Stops the closing gate.	2 nd

Press	Button B	Actuator
1 st	Opens the gate.	2 nd
2 nd	Stops the opening gate.	2 nd
3 rd	Closes the gate.	2 nd
4 th	Stops the closing gate.	2 nd
5 th	Opens the gate.	1 st
6 th	Stops the opening gate.	1 st
7 th	Closes the gate.	1 st
8 th	Stops the closing gate.	1 st

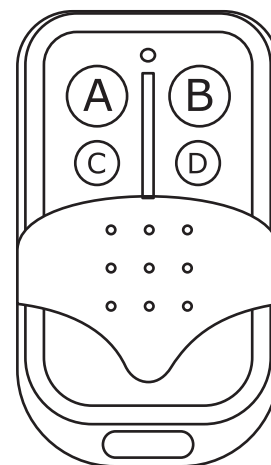

1. Toggle the rocker switch on the circuit board to “—”.

You should hear a short beep and the state indicator lights up and glows steady red.

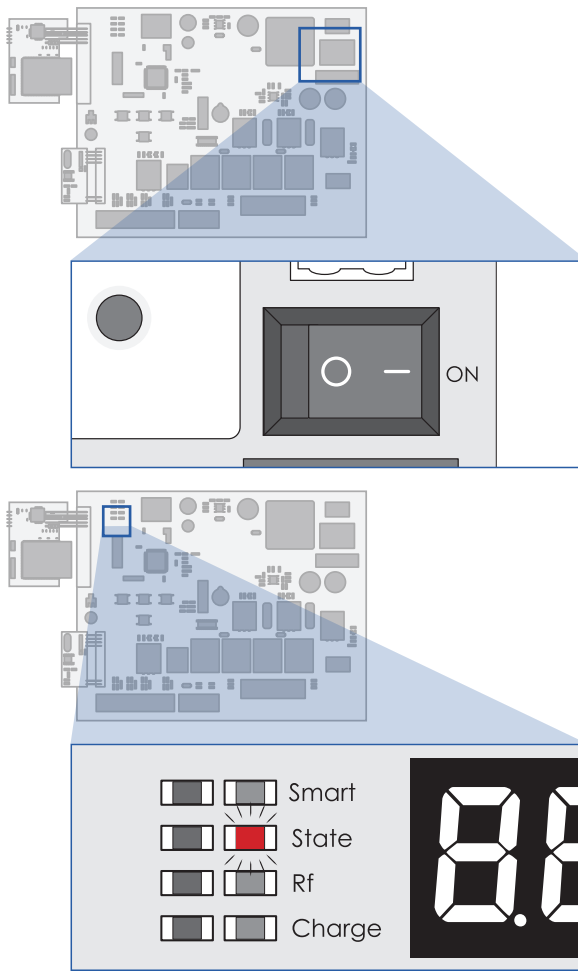

2. Press the first button to the left of the remote.

3. Check that the gate leaf attached to the 2nd actuator will move in the way as listed in the table.

Press	Button A	Actuator
1 st	Opens the gate.	2 nd
2 nd	Stops the opening gate.	2 nd
3 rd	Closes the gate.	2 nd
4 th	Stops the closing gate.	2 nd

4. (Dual-Actuators Only) Press the first button to the right of the remote.

5. (Dual-Actuators Only) Check that the gate leaves attached to the 2nd actuator and 1st actuator will move in the way as listed in the table.

Press	Button B	Actuator
1 st	Opens the gate.	2 nd
2 nd	Stops the opening gate.	2 nd
3 rd	Closes the gate.	2 nd
4 th	Stops the closing gate.	2 nd
5 th	Opens the gate.	1 st
6 th	Stops the opening gate.	1 st
7 th	Closes the gate.	1 st
8 th	Stops the closing gate.	1 st

Setting the Obstruction Sensitivity

Warning

- Clear any obstruction that is in or might come across the moving path of the gate and actuators before testing.
- Check that the obstruction sensitivity is well-adjusted to your needs. **DO NOT** skip this step, as a wrongly set obstruction sensitivity can cause fatal entrapment.

The actuators are so designed that they control the gate leaves to move fast upon receiving signal from a paired remote control and slow the leaves down when reaching the fully open/closed position.

Because of the difference in speed, the obstruction sensitivity has to be separately configured for the high speed and low speed phases of the travelling gate leaves.

Actuator 1 (high-speed phase)

1. Put a chair in the middle of the moving path of the gate leaf.
2. Press the first button to the left on the remote.

The gate should start opening and moving toward the chair.

If the gate has been stopped by the chair, then the obstruction sensitivity does not need adjustment.

If the gate has knocked down the chair and is pushing it on the ground,

- a. Toggle the rocker switch on the circuit board to “-” if it is not.

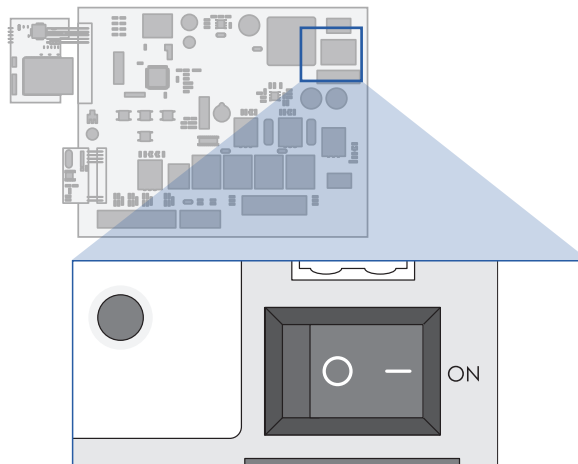

- b. Hold **Func** until the display reads **P0**.

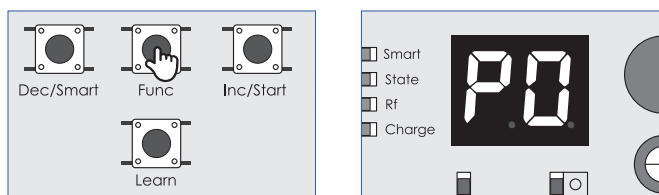

- c. Press **Inc/Start** until the display reads **P1**. Use **Dec/Smart** if you feel like pressing more.

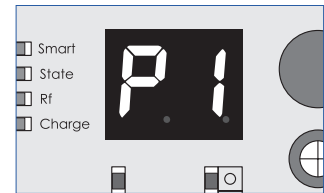

Note

Parameter P1 sets the high-speed obstruction sensitivity of the 1st actuator. The higher the value, the harder the actuator will push against an obstruction.

- d. Press **Func** and the display reads 10.
- e. Use **Dec/Smart** to decrease the value.
- f. Press **Func** to save the change and exit the current submenu.
- g. Reset the chair and repeat Step 2 and all its sub-steps **until the gate stops upon contacting the chair.**

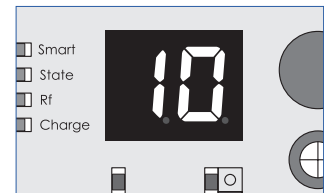

Actuator 1 (low-speed phase)

1. Put a chair near the maximal open position of the gate leaf.
2. Press the first button to the left on the remote.

The gate should start moving and nearing the chair.

If the gate has been stopped by the chair, then the obstruction sensitivity does not need adjustment.

If the gate has knocked down the chair and is pressing it against another firm object,

- a. Toggle the rocker switch on the circuit board to “—” if it is not.

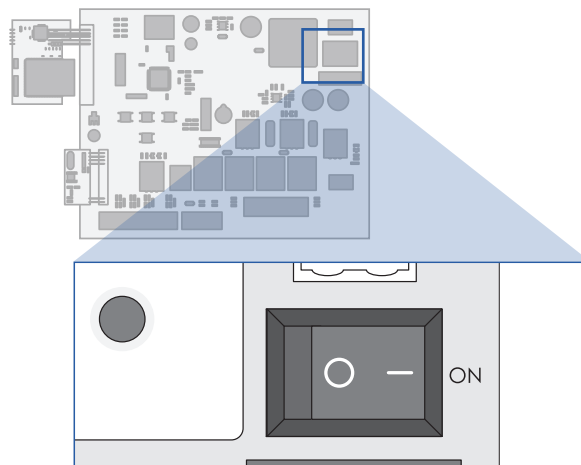

- b. Hold **Func** until the display reads **P0**.

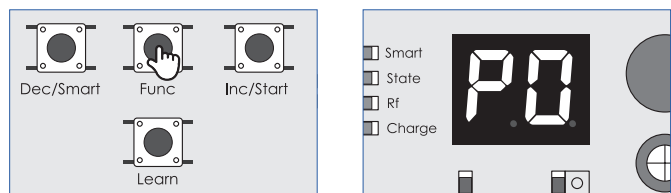

- c. Press **Func** again and the display reads **10**.

Note

Parameter P0 sets the low-speed obstruction sensitivity of the 1st actuator. The higher the value, the harder the actuator will push against an obstruction.

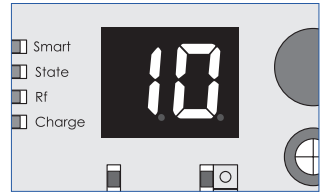

- d. Use **Dec/Smart** to decrease the value.
- e. Press **Func** to save the change and exit the current submenu.
- f. Reset the chair and repeat Step 2 and all its sub-steps until the gate stops upon contacting the chair.

Actuator 2 (high-speed phase)

1. Put a chair in the middle of the moving path of the gate leaf.
2. Press the first button to the left on the remote.

The gate should start opening and moving toward the chair.

If the gate has been stopped by the chair, then the obstruction sensitivity does not need adjustment.

If the gate has knocked down the chair and is pushing it on the ground,

- a. Toggle the rocker switch on the circuit board to “-” if it is not.

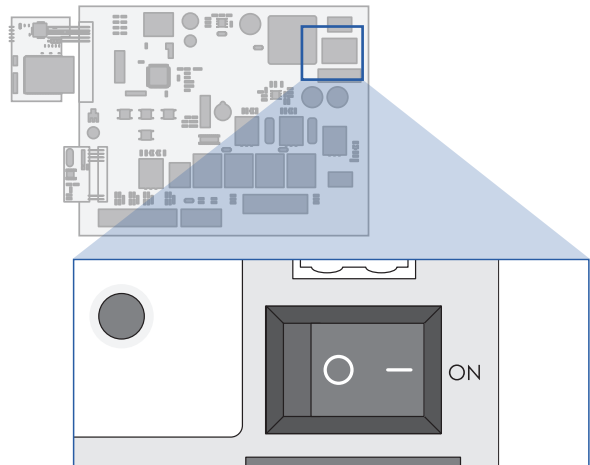

- b. Hold **Func** until the display reads **P0**.

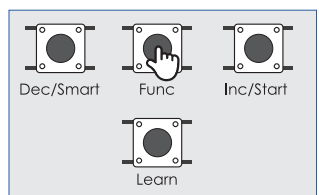

- c. Press **Inc/Start** until the display reads **P3**. Use **Dec/Smart** if you feel like pressing more.



d. Press **Func** and the display reads **10**.

Note

Parameter P3 sets the high-speed obstruction sensitivity of the 2nd actuator. The higher the value, the harder the actuator will push against an obstruction.

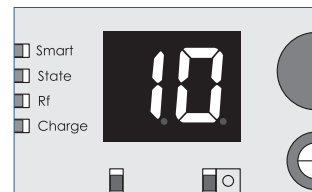

- e. Use **Dec/Smart** to decrease the value.
- f. Press **Func** to save the change and exit the current submenu.
- g. Reset the chair and repeat Step 2 and all its sub-steps until the gate stops upon contacting the chair.

Actuator 2 (low-speed phase)

1. Put a chair near the maximal open position of the gate leaf.
2. Press the first button to the left on the remote.

The gate should start moving and nearing the chair.

If the gate has been stopped by the chair, then the obstruction sensitivity does not need adjustment.

If the gate has knocked down the chair and is pressing it against another firm object,

- a. Toggle the rocker switch on the circuit board to “—” if it is not.

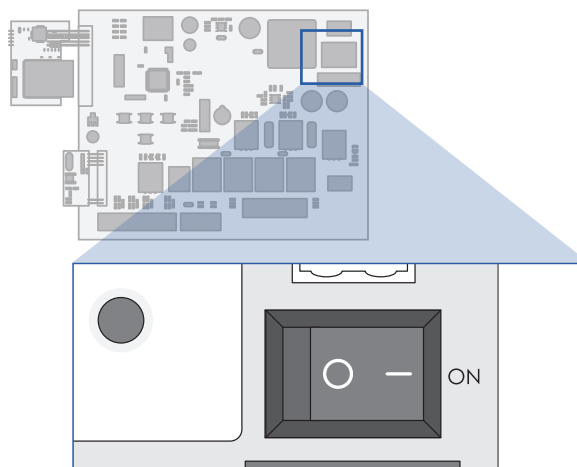

- b. Hold **Func** until the display reads **P0**.

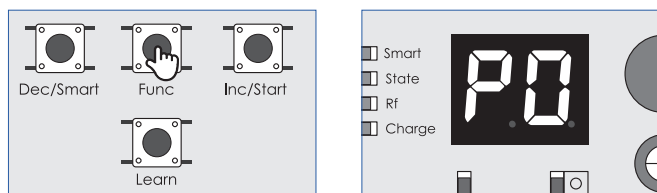

- c. Press **Inc/Start** until the display reads **P2**. Use **Dec/Smart** if you feel like pressing more.

Note

Parameter P2 sets the low-speed obstruction sensitivity of the 2nd actuator. The higher the value, the harder the actuator will push against an obstruction.

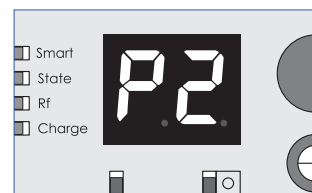

- d. Press **Func** again and the display reads **10**.
- e. Use **Dec/Smart** to decrease the value.
- f. Press **Func** to save the change and exit the current submenu.
- g. Reset the chair and repeat Step 2 and all its sub-steps until the gate stops upon contacting the chair.



Setting Opening/Closing Delay

Opening Delay

1. Toggle the rocker switch on the circuit board to “—” if it is not.

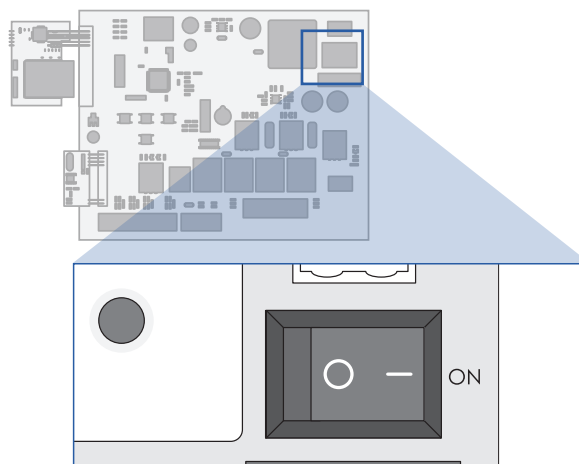

2. Hold **Func** until the display reads **P0**.

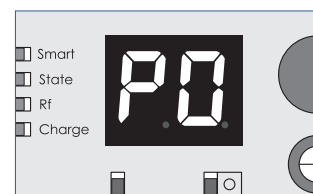
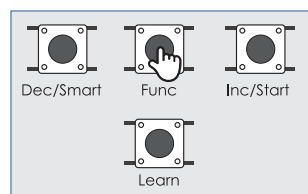

3. Press **Inc/Start** until the display reads **P7**. Use **Dec/Smart** if you feel like pressing more.

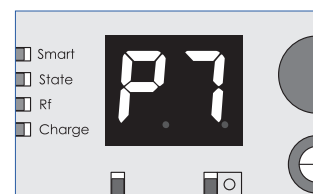

4. Press **Func** again and the display reads **02**.
5. Use **Dec/Smart** to decrease the value.
6. Press **Func** to save the change and exit the current submenu.

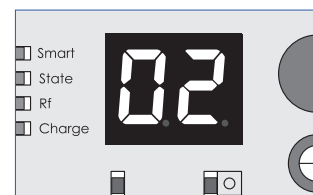

Note

- Parameter P7 sets the gate opening delay. Its value is modifiable within 0–15 seconds, with 0 meaning that the gate starts moving upon receiving a signal to open from a paired remote; 15 meaning the gate will start moving 15 seconds after receiving a signal to open.
- Customize the delay as you will need it to be.

Closing Delay

1. Toggle the rocker switch on the circuit board to “—” if it is not.

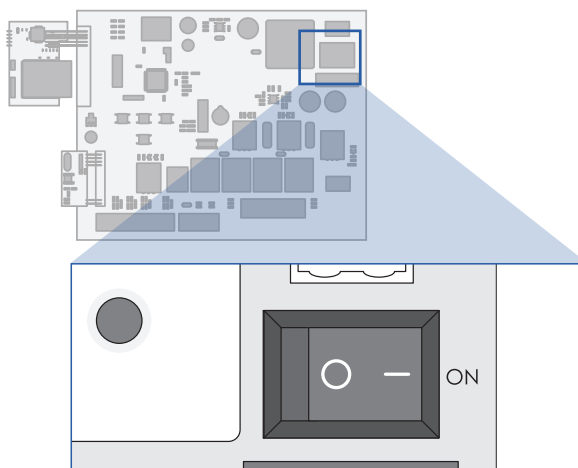

2. Hold **Func** until the display reads **P0**.

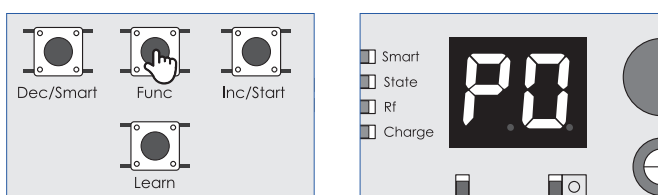

3. Press **Inc/Start** until the display reads **P8**. Use **Dec/Smart** if you feel like pressing more.

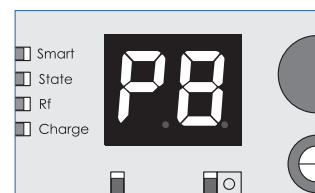

4. Press **Func** again and the display reads **02**.
5. Use **Dec/Smart** to decrease the value.
6. Press **Func** to save the change and exit the current submenu.

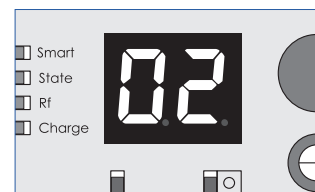

Note

- Parameter P8 sets the gate opening delay. Its value is modifiable within 0–15 seconds, with 0 meaning that the gate starts moving upon receiving a signal to close from a paired remote; 15 meaning the gate will start moving 15 seconds after receiving a signal to close.
- Customize the delay as you will need it to be.

Auto-Closing Delay

1. Toggle the rocker switch on the circuit board to “—” if it is not.

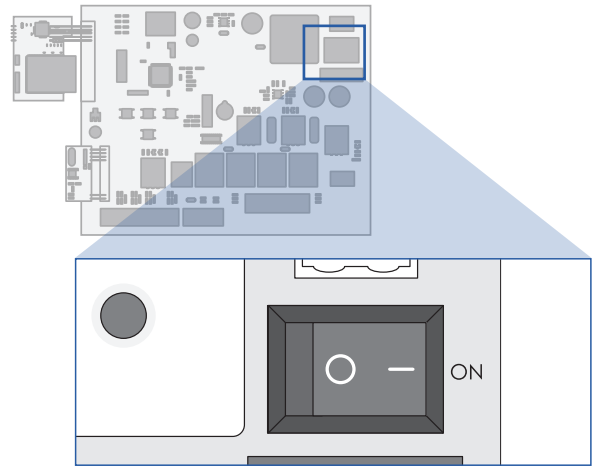

2. Hold **Func** until the display reads **P0**.

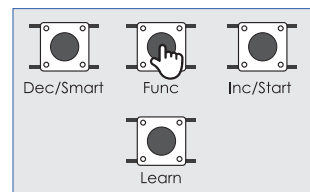

3. Press **Inc/Start** until the display reads **P9**. Use **Dec/Smart** if you feel like pressing more.



4. Press **Func** again and the display reads **00**.

5. Use **Dec/Smart** to decrease the value.

6. Press **Func** to save the change and exit the current submenu.



Note

- Parameter P9 sets the delay to close when the gate has reached the max. opening position. Its value is modifiable within 0–99 seconds, with 0 meaning that the gate starts closing upon reaching its max. opening position; 99 meaning the gate will wait for 99 seconds after reaching the max. opening position and start closing after that duration of time.
- Customize the delay as you will need it to be. But keep in mind that setting it to 0 or another short duration of time could cause entrapment. **ALWAYS** test all your vehicles with this time duration.
- Pressing button D ONLY cancels the auto-closing for once. The preset auto-closing delay will resume once the gate reaches the max. opening position.

Remote Control

Pairing

1. Toggle the rocker switch on the circuit board to “—”.

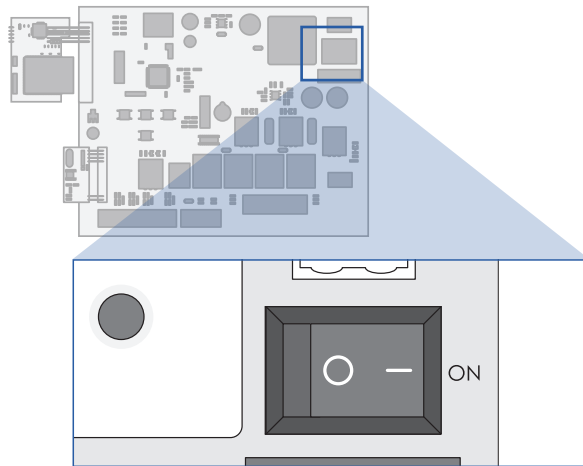

Indicator light **State** comes on.

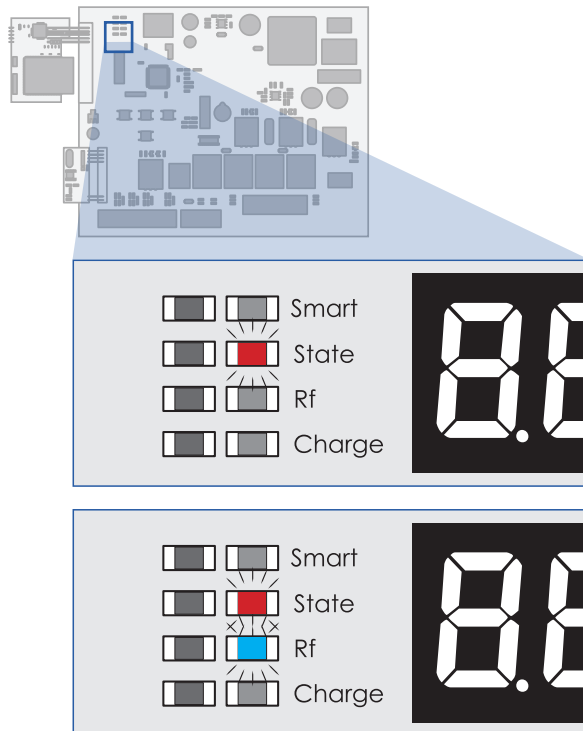

2. Press **Learn**.

Rf indicator instantly comes on and the buzzer sounds a beep.

3. Press any button on your remote.

If the remote is compatible, another beep should instantly sound. Meanwhile, the display should show a one or two-digit number, indicating the number of remotes paired to the circuit board and that the remote has been successfully paired.

Note

- The segment display has only two digits, but the circuit board has a capacity of up to 120 remotes paired.
- Because of that, if over a 100 (but within 110) remotes have been paired, the first two digits will be replaced by “AA”; if over 110 remotes have been paired, then the first two digits will be replaced by “BB”.
- If the circuit board has been fully paired, the display reads “---”.
- If no remote button is pressed within 8 seconds after Learn being pressed, the control board will automatically exit the pairing.

Unpairing

Caution

- **DO NOT** do the unpairing unless it is really necessary to do so.
- These procedures purge ALL paired remotes.

Hold **Learn** until you hear a long beep and the display shows **00**, indicating all paired remotes have been unpaired with the circuit board.



3.3.11 Display Parameters and Message Codes

This 2-digit segment display can show up to 20 parameters and 24 working status codes. Refer to the tables below for their meanings and way to adjust.

Message Codes

Below are the message codes that will show up when the actuator operates.

Message Codes	Meanings
OP	Shows up when actuator 1 starts opening the gate.
OP.	Shows up when actuator 2 starts opening the gate.
O.P.	Shows up when actuator 1 and 2 start opening the gate.
CL	Shows up when actuator 1 starts closing the gate.
CL.	Shows up when actuator 2 starts closing the gate.
C.L.	Shows up when actuator 1 and 2 start closing the gate.
--	Shows up when actuator 1 has moved to its max. opening or closing position.
--.	Shows up when actuator 2 has moved to its max. opening or closing position.
--.	Shows up when actuators 1 and 2 have moved to their max. opening or closing position.
OH	Shows up when actuator 1 has met an obstruction during high-speed phase.
OH.	Shows up when actuator 2 has met an obstruction during high-speed phase.
O.H.	Shows up when actuators 1 and 2 have met an obstruction during high-speed phase.
OL	Shows up when actuator 1 has met an obstruction during low-speed phase.
OL.	Shows up when actuator 2 has met an obstruction during low-speed phase.
O.L.	Shows up when actuators 1 and 2 have met an obstruction during low-speed phase.

Message Codes	Meanings
EC*	Shows up when the overload protection of actuator 1 has been tripped.
EC.*	Shows up when the overload protection of actuator 2 has been tripped.
E.C.*	Shows up when the overload protection of actuator 1 and 2 have been tripped.
PH	Shows up when the IR sensor has been triggered.
LO	Shows up when actuator 1 has reached its max. opening position.
LO.	Shows up when actuator 2 has reached its max. opening position.
LC	Shows up when actuator 1 has reached its max. closing position.
LC.	Shows up when actuator 2 has reached its max. closing position.
Lb	Shows up when the battery is running out.









Note







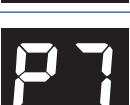



*Both actuators trigger their overload protection after 60 seconds of continuous running. The overload protection also trips if the low-speed phase exceeds 30 seconds.

Parameters

All the parameters can be accessed through the following steps.

1. Hold **Func** until **P0** shows up.
2. Use **Inc/Start** or **Dec/Smart** to toggle through the parameter menu.
3. Stop when you see the parameter whose value needs adjusting.
4. Press **Func** to enter the parameter submenu, where the value of the parameter is shown.
5. Use **Inc/Start** or **Dec/Smart** to change the value.
6. Press **Func** to save the change. You should hear a short beep if the change was successful.
7. Press **Learn** to exit the parameter menus and turn off the display.

Parameters	Value Ranges	Defaults	Meaning
	0-20	10	Sets the obstruction sensitivity of actuator 1 during low-speed phase. The higher the value, the harder the actuator will push against obstruction.
	0-20	10	Sets the obstruction sensitivity of actuator 1 during high-speed phase. The higher the value, the harder the actuator will push against obstruction.
	0-20	10	Sets the obstruction sensitivity of actuator 2 during low-speed phase. The higher the value, the harder the actuator will push against obstruction.
	0-20	10	Sets the obstruction sensitivity of actuator 2 during high-speed phase. The higher the value, the harder the actuator will push against obstruction.
	3-30	10	Sets the duration of the high-speed phase of actuator 1.
	3-30	10	Sets the duration of the high-speed phase of actuator 2.
	0-99	10	Sets the auto-closing delay activated by a card. To disable this parameter, set the value to 0.
	0-15	2	Sets the opening delay. To disable this parameter, set the value to 0.
	0-15	2	Sets the closing delay. To disable this parameter, set the value to 0.
	0-99	0	Sets the auto-closing delay. To disable this parameter, set the value to 0.

Parameters	Value Ranges	Defaults	Meaning
	0-1	0	Sets the status of an alarm lamp. 1: Keeps the alarm lamp on while the gate is moving. Turns it off when the gate stops. 0: Keeps the alarm lamp on while the gate is moving. Turns it off after the gate has stopped for 30 seconds.
	0-5	0	Sets the functioning time of the electric lock. 0: Turns the electric lock off.
	0-1	1	Sets the work mode of the electric lock. 0: Means the electric lock remains energized and locked all the time except when opened by cutting off the circuit. 1: Means the electric lock remains unenergized and locked all the time except when opened by a closing the circuit.
	0-3	0	Controls the 2Side terminal. 0: Sets the device connected to the terminal to repetitively control actuators 1 and 2 in such an order: open>stop>close>stop . 1: Sets the device connected to ONLY open the gate(s). 2: Sets the device connected to ONLY close the gate(s). 3: Disables this terminal.
	0-3	0	Controls the 1Side terminal. 0: Sets the device connected to the terminal to repetitively control actuator 2 in such an order: open>stop>close>stop . 1: Sets the device connected to ONLY open the gate(s). 2: Sets the device connected to ONLY close the gate(s). 3: Disables this terminal.
	0-1	1	Sets the work mode of the IR sensors. 0: NC. 1: NO.
	0-1	0	Sets the number of the actuator controlled. 0: Dual actuator 1: Single actuator
	0-10	6	Sets the duration of the low-speed phase.
	0-1	0	Sets the way the circuit board perceives a limit stop. 0: Mechanical limit stop 1: Electric limit stop
	0-10	0	Resets the value of a selected parameter among P0-P9, with 1 referring to P0 and 10 to P9.

3.4 Pull-to-Open Installation (PLO)

3.4.1 Locating the Center Line

Tools Needed but Not Included

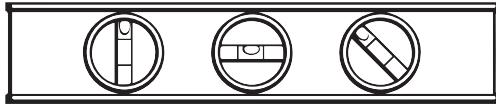

Level

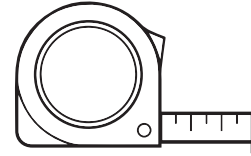

Tape Measure

Use your level and tape measure to find out the center line of your gate leaves and posts.

Note

This centerline will be used for mounting the post bracket.



3 INSTALLATION Top Mounting	Not recommended—could cause the gate to be flexed or twisted.	
Center Line Mounting	Recommended—allows even force to be applied to the gate.	
Bottom Mounting	Not recommended for the same reason for the top mounting.	

3.4.2 Post Bracket Pre-Assembly and Location

Tools Needed but Not Included

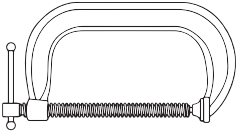

Clamp



Adjustable Wrench × 1



Cordless/Corded Drill

OR

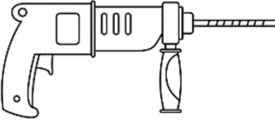

Hammer Drill



12 mm Regular or Masonry Drill Bit

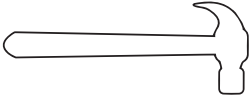

Regular Hammer

Hardware Needed

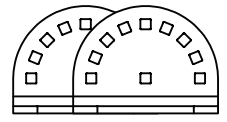

Rear Brackets × 2

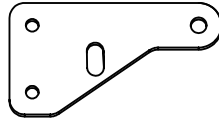

Rear Bracket Plate

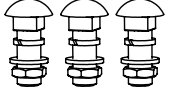

Rear Bracket Bolts and Nuts × 3

1. Assemble the post bracket the way shown.

 **Caution**

Do not fully tighten the bolt sets yet.

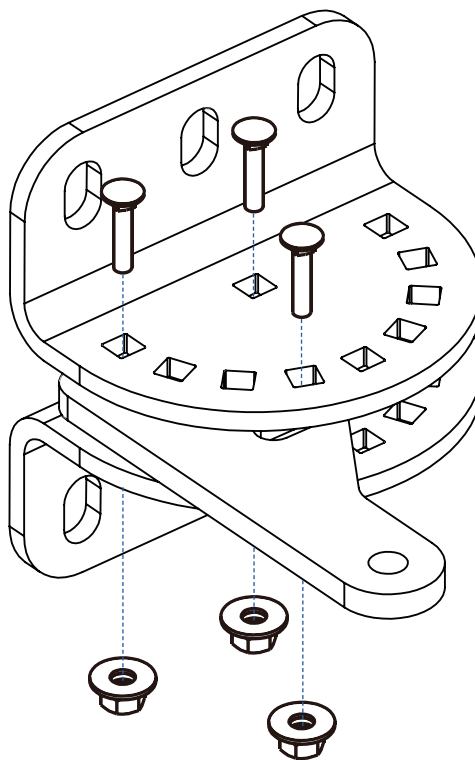

2. Clamp the pre-assembled post bracket to the gate post, making sure the rear bracket plate superimposes the center line.

Note

- For wooden, cylindrical posts, notch the posts per the dimensions of the post bracket.
- For posts made of materials other than wood, make sure they provide a flat interface (5 in. by 5 in.) with the post bracket.

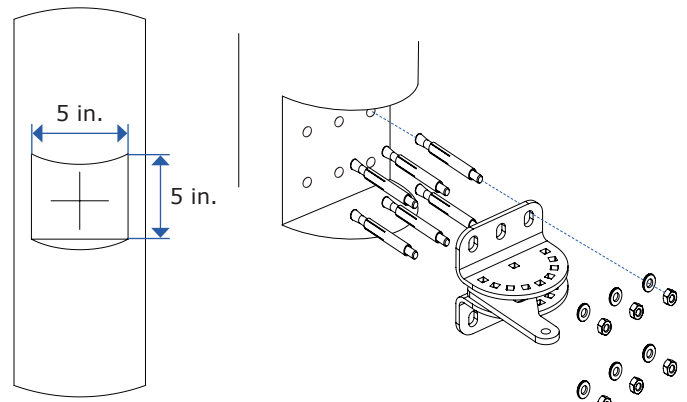
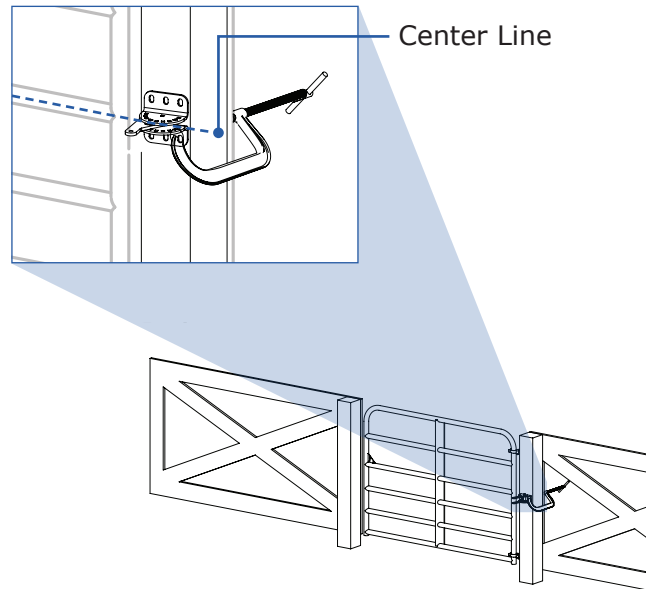

3. Adjust the position of the rear bracket, making sure the mounting hole on the rear bracket plate is at least 5.4 in. away from the bar/surface, where the actuator is going to be mounted.

4. Once the position of the rear bracket has been determined, fully tighten the nuts on the bracket.

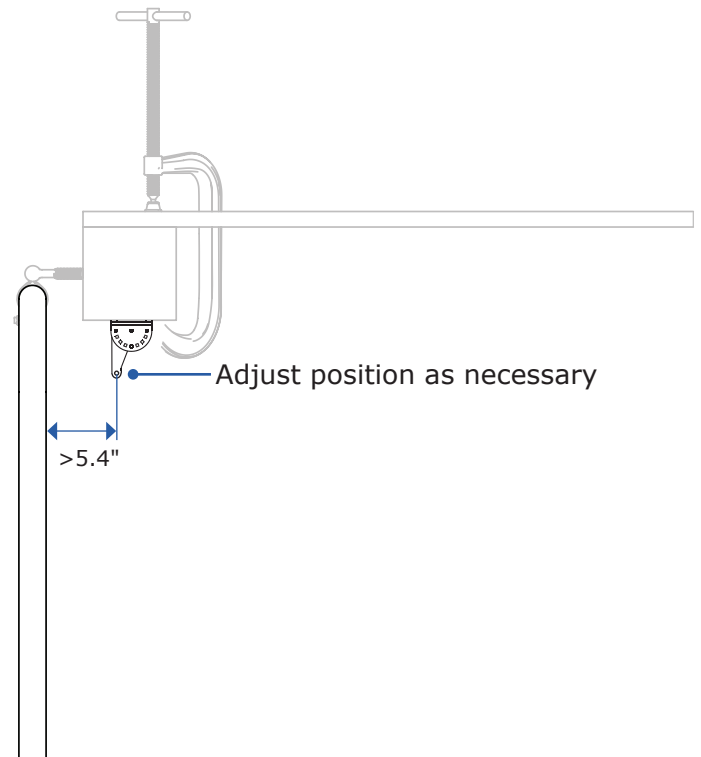

3.4.3 Mounting the Post Bracket

Tools Needed but Not Included

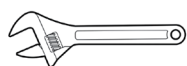

Adjustable Wrench × 1



Cordless/Corded Drill

OR

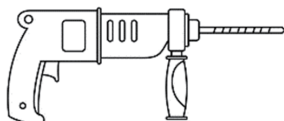

Hammer Drill



12 mm Regular or Masonry Drill Bit



Regular Hammer

Hardware Needed

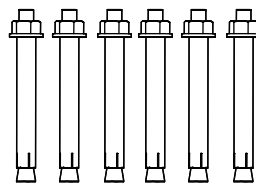

M10×150 mm Expansion Bolts × 6

Note

- The provided expansion bolts are for mounting on masonry posts. For posts made of other materials, use correct fasteners.
- The provided bolts are 150 mm in length, which are meant for anchoring into your posts. If they are so long as to impale your post, use alternatives that won't.

Mounting on wood, however, requires full penetration of the posts; make sure you have fasteners of the correct length and type.

1. With the rear bracket clamped to the gate post, mark where the holes should be for the expansion bolts.

Warning

Follow all the protocols concerning the safe use of electric drills or hammer drills.

2. Drill each hole where the mark was made.
3. With the nuts on the expansion bolts unmoved, hammer the expansion bolts into the drilled holes.
4. Remove the nuts.
5. Bolt the rear bracket to the gate post using the correct fasteners.

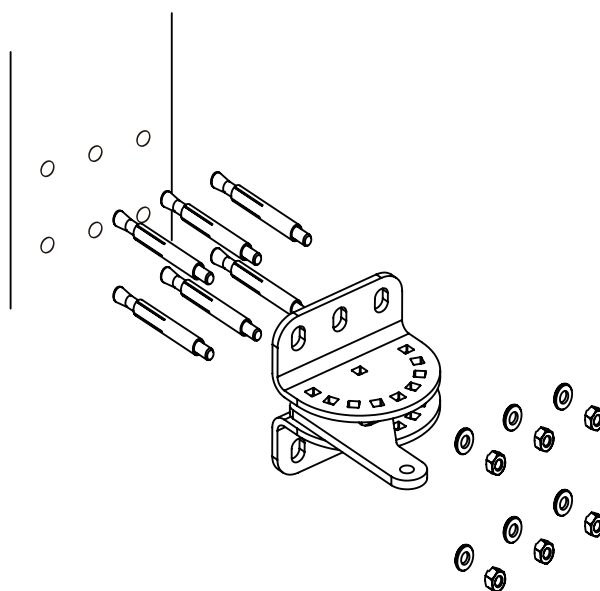

3.4.4 Connecting the Actuator

Tools Needed but Not Included

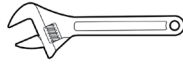

Adjustable Wrench × 1

Hardware Needed



Rear Mounting Bolt & Nut

Connect the actuator to the mounted rear bracket using a pair of rear mounting bolts and nut.

Warning

DO NOT leave the actuator hanging in the air while working on the following installation steps; hook it to the gate bars or seek help to hold it.

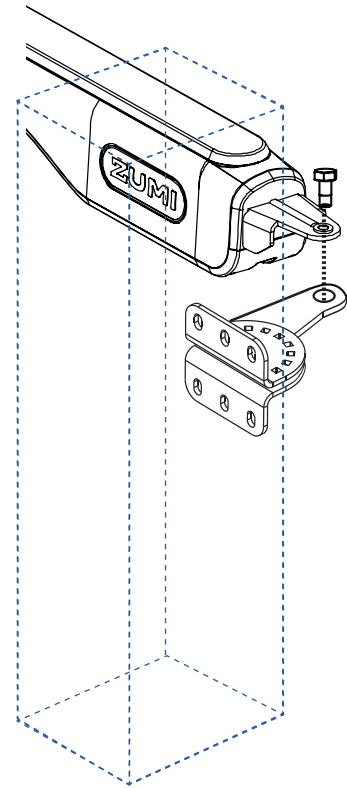

3.4.5 Mounting the Control Box

Tools Needed but Not Included

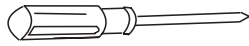

Phillips Screwdriver

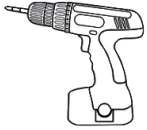

Cordless/Corded Drill

OR

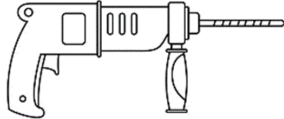

Hammer Drill



12 mm Regular or Masonry Drill Bit

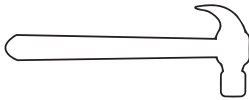

Regular Hammer

Hardware Needed

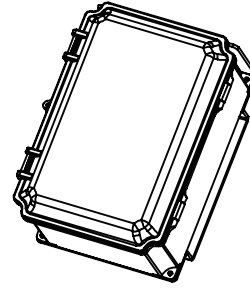

Control Box

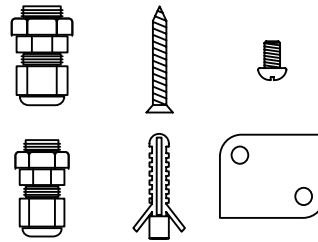

Preparing the Control Box

1. Release the latches on the control box and remove the circuit board and battery (if included).
2. From inside the control box, remove the knockouts with any tool appropriate for the job.

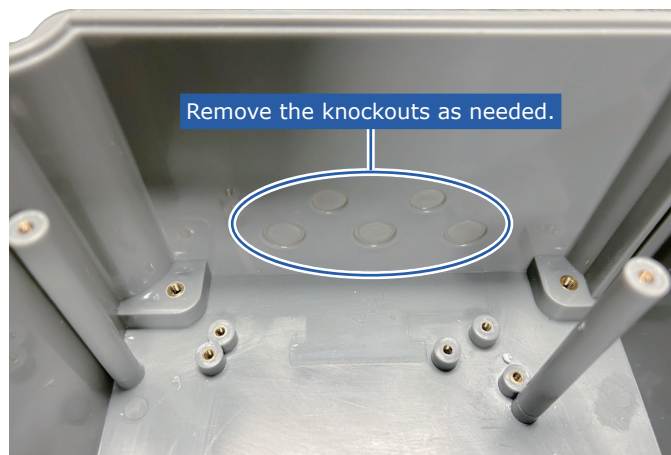

3. Remove the nut on any of the cable glands, insert it into the newly created hole, and fasten it using its removed nut.
4. Install the remaining cable glands in the same way.

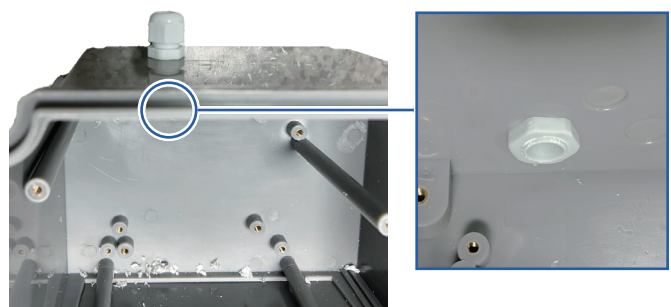

Mounting

Warning

- Mount the control box a minimum of 3 feet above the ground to keep dirt and water from damaging the control board and within 4 feet of the actuator arms in order for the operator cable to reach the control box.
- Mounting the box upside down WILL risk short-circuiting the circuit board. Make sure the cable glands will face the ground.
- The control box has a seal that can protect its insides from mild precipitation. For maximum safety, install a shade for it.
- Once the whole system is up and running, lock the control box's lid with a padlock.

1. Making sure no battery is inside, flip the control box.
2. Slide any mounting bracket to complete the corner of the box.
3. Fasten the bracket to the box using the mounting bolt.
4. Repeat for the remaining box corners.
5. Press the assembled control box and its brackets against the surface on which it will be mounted.
6. Mark the surface through the remaining holes on the mounting brackets.
7. Remove the box and drill a hole where the mark was made.
8. **Attach the control box** using the anchor bolts.



3.4.6 Wiring the Actuator

Warning

- For optimal safety, we recommend the wiring be done by a certified electrician.
- (Optional) If your models have two actuators, protect the cable of the one further from the control box.
- If you have only one actuator and your door is single-leafed, connect the wires of your actuator to **MOTOR 2**.
- For models that come with no battery and solar panel, we recommend using a transformer able to handle the electrical draw of the circuit board.
- For a longer battery service life and a pleasant experience of this automatic gate opening system, we recommend using the provided battery in conjunction with the solar panel, which should maintain the battery's optimal performance and preclude the possibility of an over-discharged battery.
- The LCD will show "Lb" when the battery is running out. Charge it use a compatible charger.
- Whatever the model of your gate opener is, be it single motor or dual motor, we recommend that you use a solar panel as a power supplement for the battery. If you must have to solely rely on the batteries, keep a regular check on the LCD.

Tools Needed but Not Included



Wire Stripper

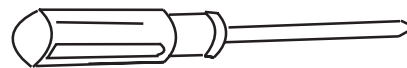

Phillips Screwdriver

Battery

1. Strip the wire ends to expose wire long enough to wrap around the bolt on the terminal blocks.
2. Connect the **BLUE** wire of the actuator to the right terminal of **MOTOR 2** on the circuit as shown.
3. Connect the **RED** wire to the left terminal of **MOTOR 2**.

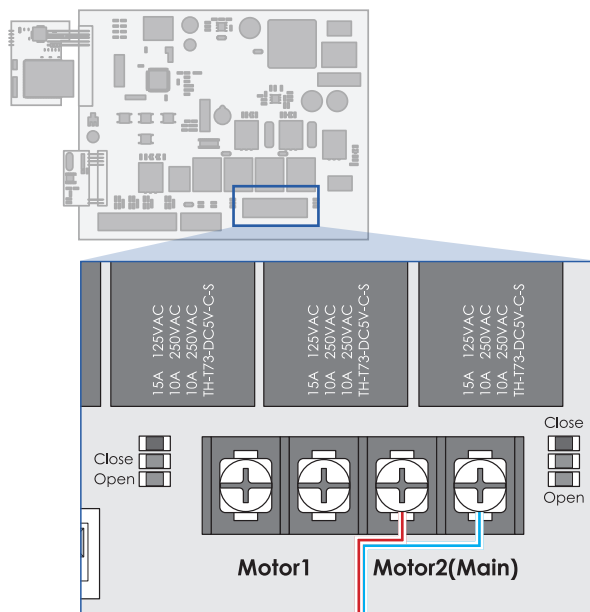

4. Set two batteries into their compartment over the circuit board.

If their wiring has become loose, tighten the connection(s) using pliers.

5. Insert the battery plug into the terminal on the circuit board as shown.

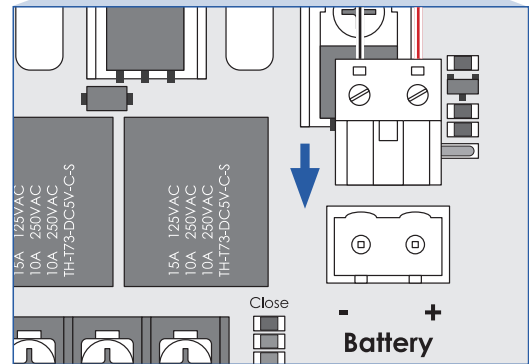
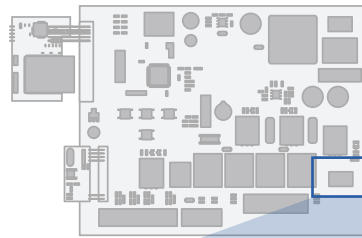

Solar Panel

Warning

- As before, we recommend the wiring be done by a certified electrician.
- For maximum compatibility between and functionality of the devices, we recommend that you use authentic parts from ZUMI. For your convenience, the SKU for the solar panel is AGO-ZUMI-04.
- **DO NOT** connect the electrodes of the same battery or let their wires to accidentally contact, as this **WILL FRY THE BATTERY**.
- This steps below are for connection with a ZUMI solar controller. For connecting one of a different brand, refer to its manual.
- **DO NOT** connect the assembled solar panel and battery to the POWER terminal on the circuit board. Use the BATTERY board.

Wiring

Wire your solar panel as shown.

1. Connect the battery output (**RED**) of the solar panel to the **RED** wire of the battery set.
2. Connect the battery input (**BLACK**) of the solar panel to the **BLACK wire of the** battery set.
3. Insert the load output (**RED**) to the negative terminal on the circuit board. Fasten the screw.
4. Insert the load input (**BLACK**) to the positive terminal on the circuit board. Fasten the screw.
5. When finished with connecting, check that **Charge** indicator is on. If it is not, reconnect using the steps above.

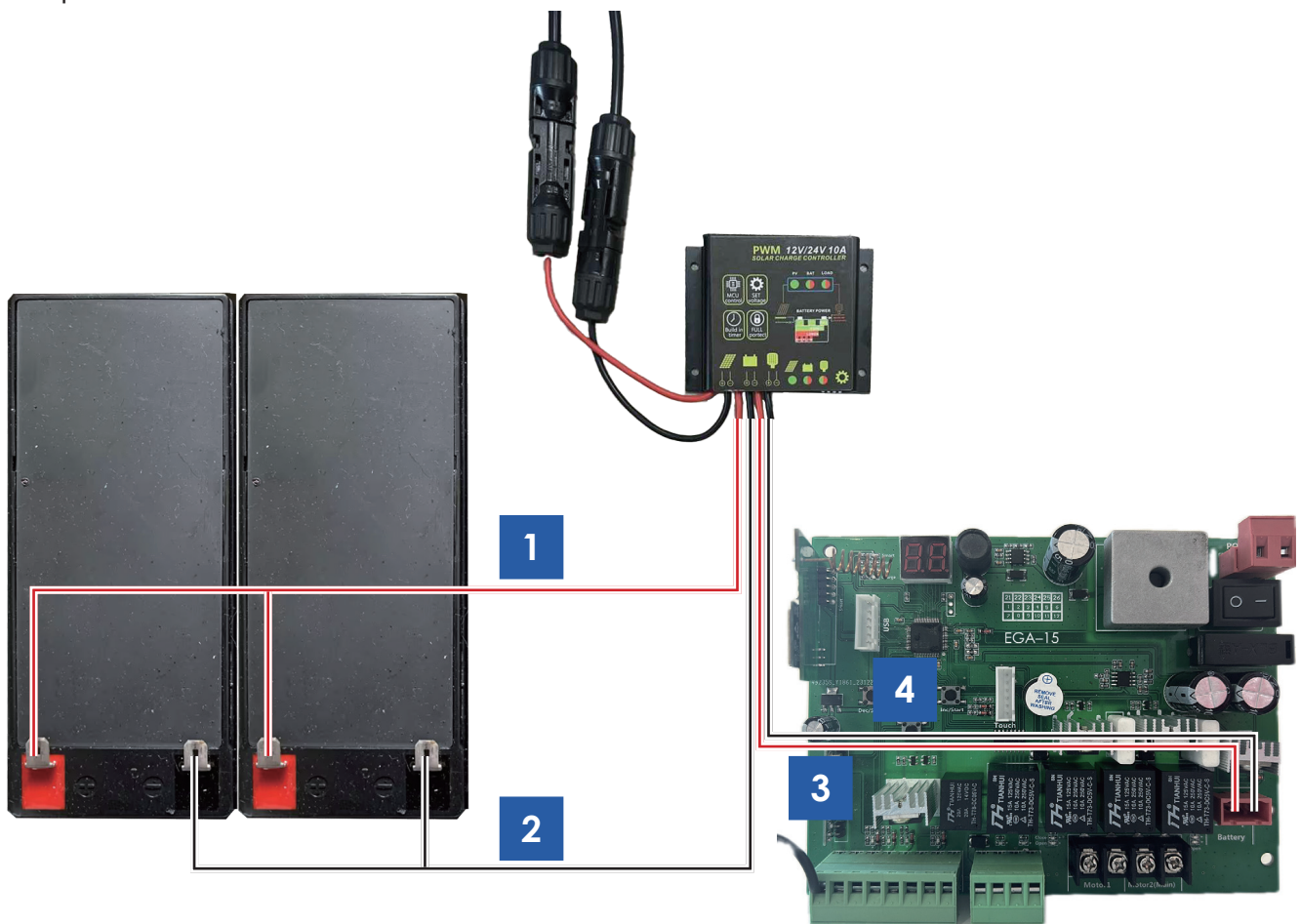

Solar Chart

Note

- The table and map illustrate the maximum number of gate cycles to expect per day in a particular area when using from 5 to 30 watts of solar charging power before the batteries deplete.
- The figures shown are for winter (minimum sunlight) and do not account for the use of any accessory items.

No. of Solar Panel	Solar Panel Ratings	Zone 1	Zone 2	Zone 3
1	12V Solar Panel (10W)	4	6	8
	12V Solar Panel (20W)	8	12	15
	12V Solar Panel (30W)*	12	18	23
2	12V Solar Panel (10W)	8	12	15
	12V Solar Panel (20W)	16	24	30
	12V Solar Panel (30W)*	24	36	46

*For maximum compatibility between and functionality of the devices, we recommend that you use authentic parts from ZUMI. For your convenience, the SKU for the solar panel is AGO-ZUMI-04(ZSP1).

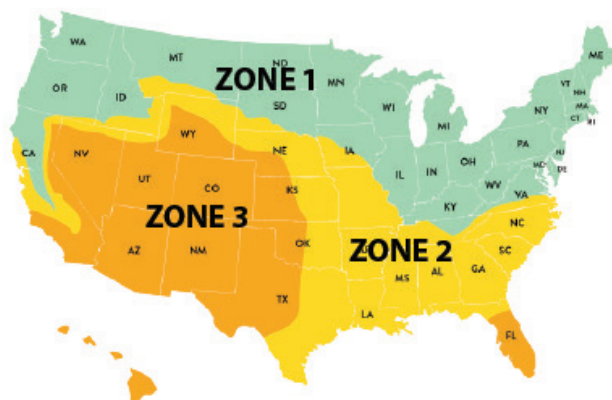

Transformer

Warning

- If a transformer is to be used to power the circuit board and the actuator(s), make sure you connect it to the terminal marked **POWER** on the circuit board.
- **NEVER USE YOUR TRANSFORMER, SOLAR PANEL AND BATTERIES AND THE SAME TIME, AS THE CIRCUIT BOARD WILL BE INSTANTLY FRIED.**

3.4.7 Mounting the Front Bracket

As mentioned before, the front and rear brackets should be mounted on the center line of your gate. However, such a line might be imaginary if your gate does not have a horizontal bar that seats perfectly where the centerline is or if your gate poses a specific challenge that will make mounting the front bracket on the centerline impossible.

To solve these, see below.

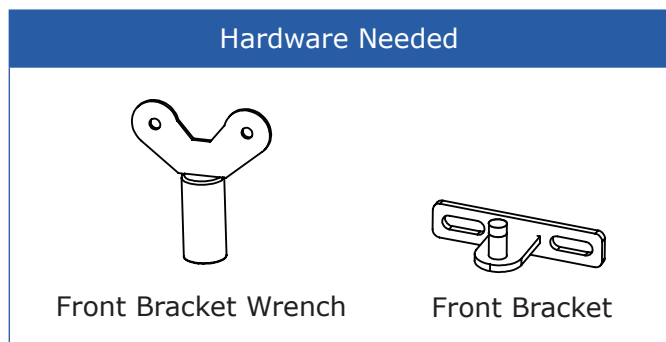

Preparing the Gate

1. Use the front bracket wrench to loosen the square bolt at the tip of actuator.
2. Insert the pivot of the front bracket in to the hole at the actuator tip.
3. Lock the square bolt using the same wrench until the bolt retains the front bracket but is not pressed against each other.
4. Close your gate.
5. Flip the button on the circuit board to “—”.

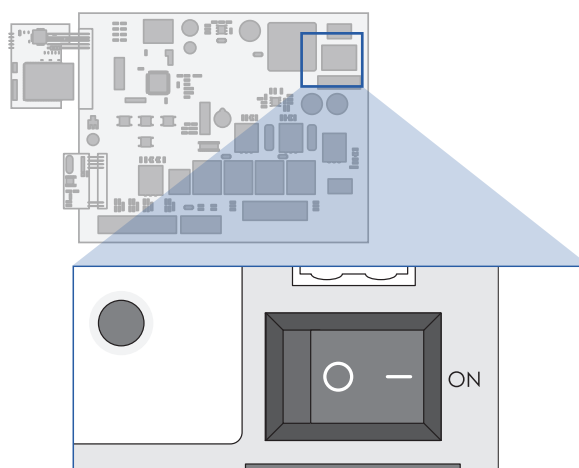
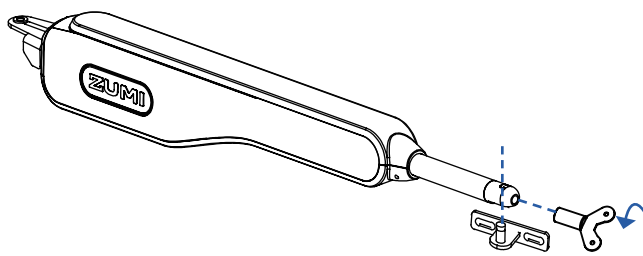

6. Press button B on either of the remotes.
The rod on the actuator should start to extend.

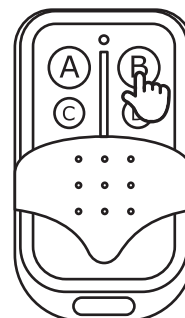

7. Wait till its fully extended.

 **Warning**

DO NOT mount the actuator with it energized.

8. After the rod has fully extended, flip the button on the circuit board to "O".

9. Press the **front bracket tight against the gate panel/bar.**

10. Use the following steps to prepare your gate panel or bar.

- For gates that do not have a horizontal bar at the center line, attach a horizontal or vertical cross-member (not included) for reinforced mounting of the front bracket.

As shown, the front bracket can be attached to the base of the muffler clamp (not included).

Note
The U-shaped brackets and the reinforcement panel are not included as accessories. Buy ones that fit.

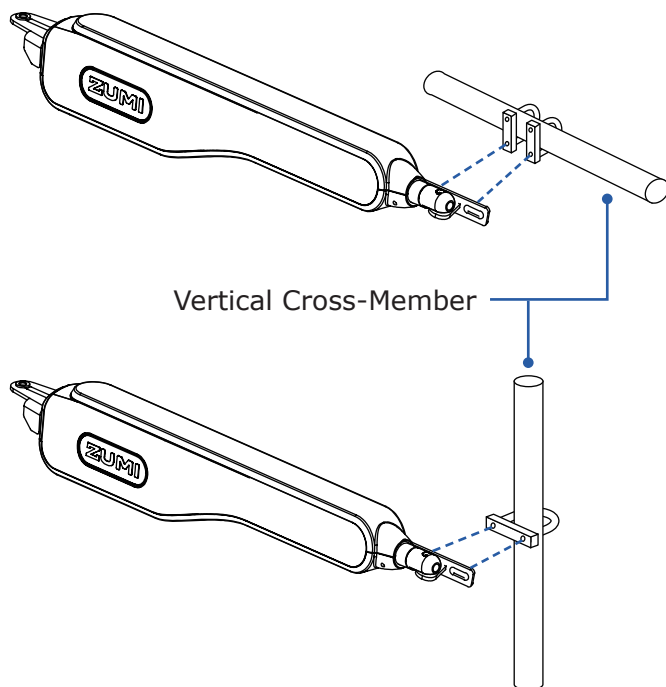

- Similarly, if your gate consists of multiple horizontal or vertical bars, using muffler clamps to attach the front bracket will provide a solid connection.

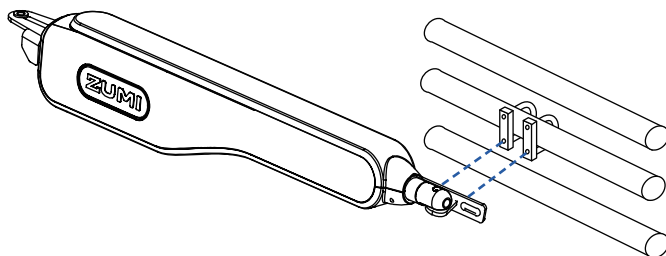

- If a single bar of your gate is not robust enough to take the force of the actuator, reinforce the bars with a metal sheet.

 **Warning**

WE RECOMMEND THIS BE DONE BY PROFESSIONALS.

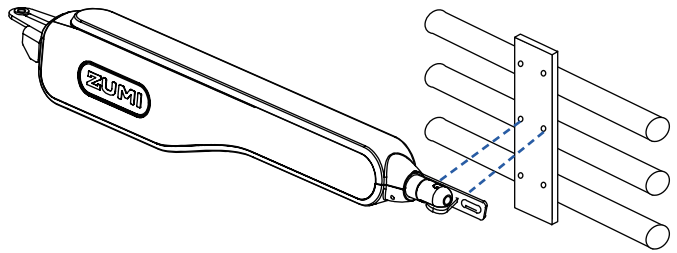

- For gates that have panels, do the same to ensure that the gate panel can take the force of the actuator.

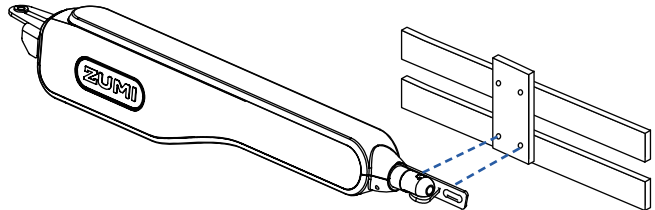

 **Warning**

Alternatively, holes can be drilled into the horizontal/vertical bar/cross-member. This kind of work, however, requires professionalism and expertise. **WE RECOMMEND THIS BE DONE BY PROFESSIONALS.**

Mounting

Tools Needed but Not Included

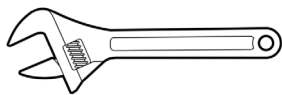

Adjustable Wrench × 1

Hardware Needed



M8×70 Bolts × 2



M8 Nuts* × 2



M8 Spring Washers × 2

1. Loosely attach the front bracket to your gate using the holes you created on the gate bar correct fasteners.

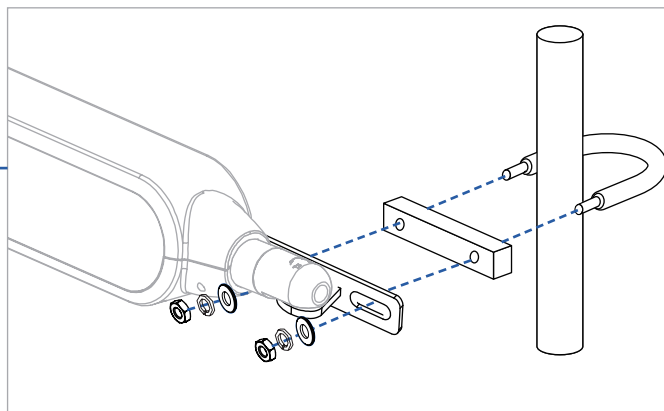
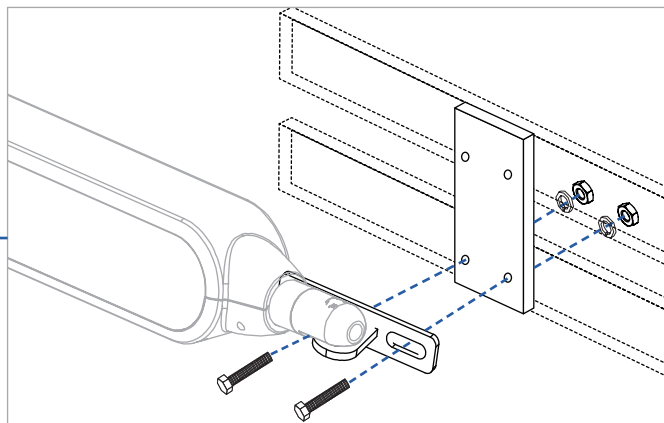
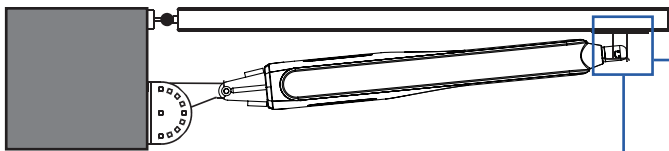

2. Open the control box and toggle the rocker switch to –.

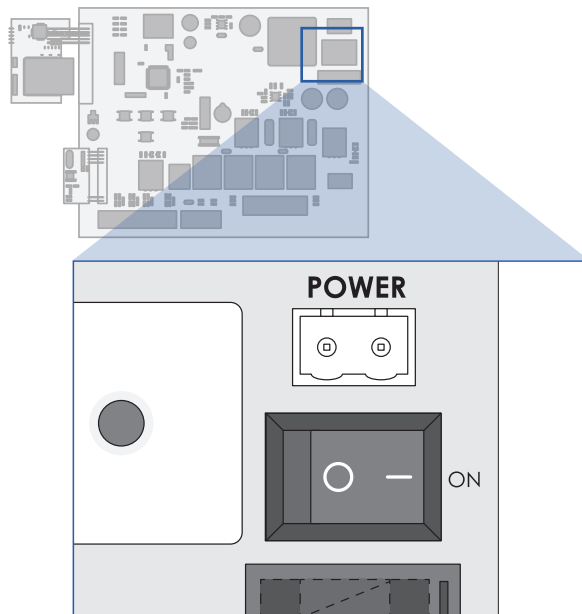

3. Press either of the top two buttons on either of the provided remote controls to extend the actuator's arm, opening the gate.
4. Press the other button of the top two buttons to fully close the gate.
5. Check that the actuator is so positioned that it will open and close your gate leaf to the desired extent. If necessary, adjust the position of the front and rear brackets.
6. When finished with checking the positions of those brackets, fully tighten the nuts of the front bracket.

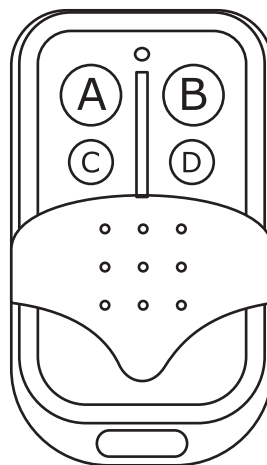

3.4.8 Installing the Limit Stop

Tools Needed but Not Included

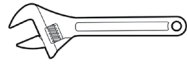

Adjustable Wrench × 1



Cordless/Corded Drill

OR

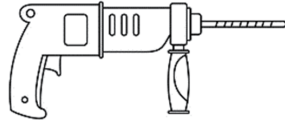

Hammer Drill



10 mm Regular or Masonry Drill Bit

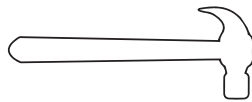

Regular Hammer

Hardware Needed

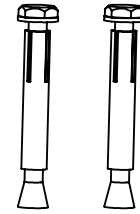

M8x60 Expansion Bolts × 2

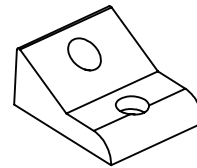

Limit Stop

1. Using your hammer drill or regular drill, drill two holes at where the gate stops.

Caution

- Note that the hole **MUST** be inside your property.
- If the ground about where the gate leaves meet is not concrete, make it so. Anchoring the limit stop to soil would render it useless.
- If the limit stop is too short for the gate-ground clearance, use a higher one (not included) but **DO NOT** skip on this.

2. With the nuts unmoved, hammer the two expansion bolts into the holes you drilled.
3. Bolt the limit stop to the expansion bolt studs.

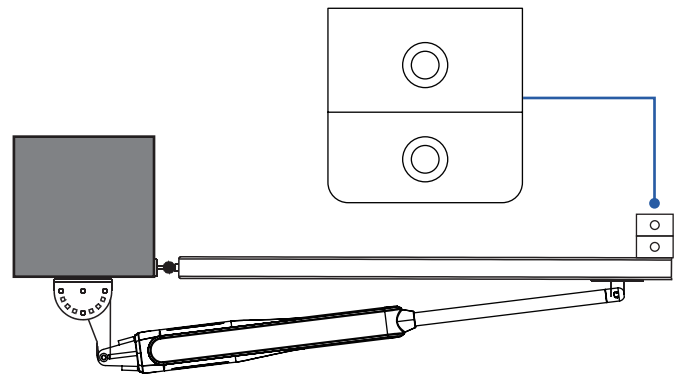

3.4.9 Installing a Second Actuator

If you have purchased a dual-actuator model, install the other actuator following the same steps as in § **3.4.1–3.4.9**.

 **Warning**

Wire the second actuator to the vacant motor terminals the same way as for actuator 1(Main).

3.4.10 Programming

Circuit Board

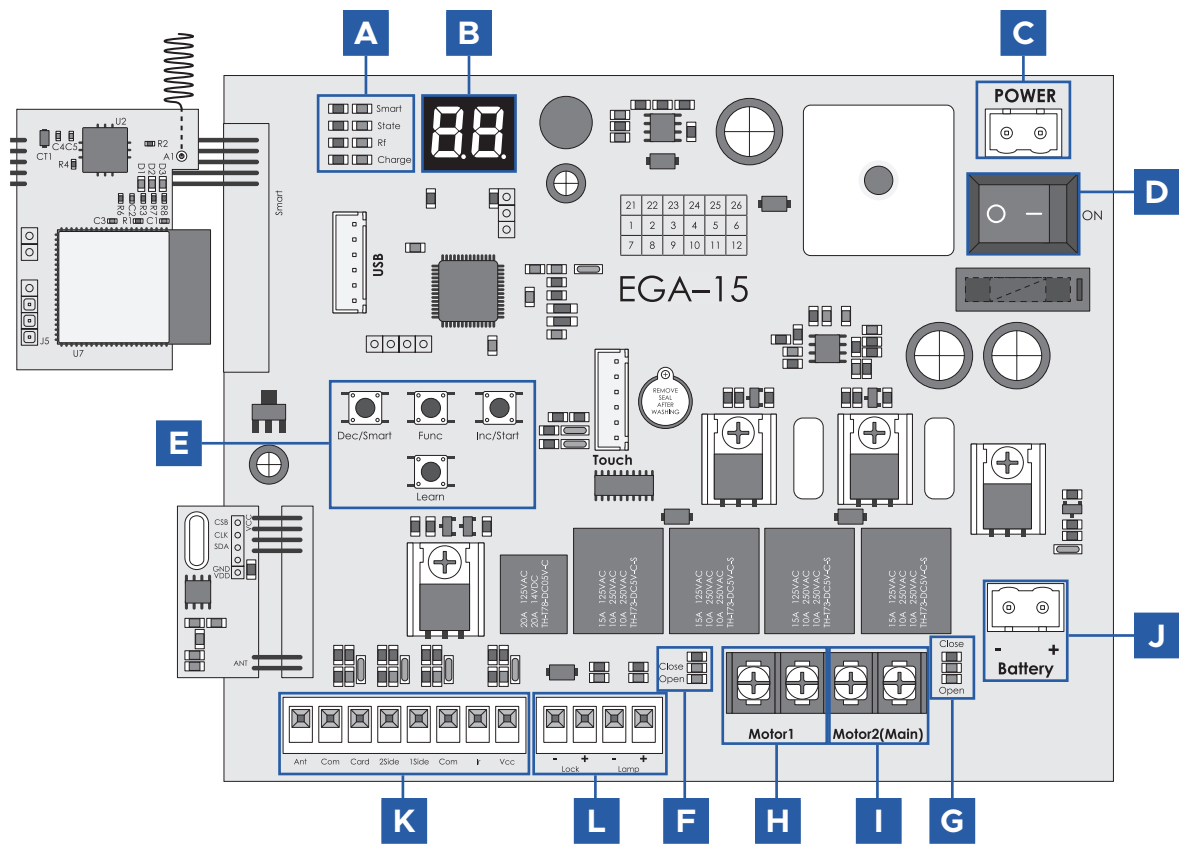

A	Indicator lights	Smart (blue)	Indicates the working status of the smart module.
		State (red)	<ul style="list-style-type: none"> Lights up and stays glowing if the system has been initialized normally. Flash once a second during gate closing countdown.
		Rf (blue)	<ul style="list-style-type: none"> Indicates the pairing and unpairing status of a remote control. Starts flashing upon receiving a signal emitted from a remote of the same brand as the circuit board, independent of whether such remote has been paired or not before.
		Charge (red)	<ul style="list-style-type: none"> Lights up and stays on when the battery is being charged. Lights up when the battery is not being charged and when the voltage of the battery is below $13.5V \pm 0.5V$.
B	Display	Shows 20 parameters and 10 codes. For details, see Display Parameters and Message Codes on Page77.	
C	12 V Power Input (DC)	Connects to a 12V DC power supply. Remove the battery plug if this input is to be used.	
D	Main Power Switch	Turns the whole system on and off.	

E	Function Buttons	Dec / Smart	<ul style="list-style-type: none"> Decreases the value of a parameter in a menu. Toggles the parameters in the descending order. 	
		Func	<ul style="list-style-type: none"> Holding it for 3 seconds and releasing enters parameters menus. Pressing it once saves the change to a parameter. 	
		Inc/ Start	<ul style="list-style-type: none"> Increases the value of a parameter in a menu. Toggles the parameters in the ascending order. 	
		Learn	<ul style="list-style-type: none"> When in the parameter menus, pressing it once exits a parameter value and dims the display. When in the main menu, pressing it once enters the remote pairing. Holding it for 6 seconds purges all the paired remotes. 	
F	Motor 1 Indicator Lights	<ul style="list-style-type: none"> Glow blue when the gate is opening. Glow red when the gate is closing. 		
G	Motor 2 Indicator Lights	<ul style="list-style-type: none"> Glow blue when the gate is opening. Glow red when the gate is closing. 		
H	Motor 1 Terminals	Connects to actuator 1.		
I	Motor 2 Terminals	Connects to actuator 2. Caution: <i>If only one actuator is to be used, connect it to the terminals of motor 2.</i>		
J	12 V Battery Input	Connects to the two provided 12V batteries or equivalents.		
K	Terminal Block 1	Ant	Connects to the antenna.	
		Com	Common ground for terminal block 1.	
		Card	Connects to a swipe-card control.	
		2Side	Connects to a keypad/single button key.	
		1Side	Connects to a keypad/single button key.	
		Com	Common ground for terminal block 1.	
		Ir	Connects to infrared sensors.	
L	Terminal Block 2	Lock	-	Connects to the negative pole of the lock.
			+	Connects to the power input of an electric lock. The voltage changes as the input power changes.
		Lamp	-	Connects to the negative pole of the lamp.
			+	Connects to the power input of an alarm lamp. The voltage changes as the input power changes.

Initial Setup

Testing the One-Button Mode

Warning

- Run this test before actually using this automatic gate system.
- Check that the actuator opens and closes the gate in the right directions following the signals of the provided remote.
- Clear any obstruction that is or might come into the moving path of the gate and actuators before testing.

The two remotes have been pre-paired at the factory. Both have the same functions. Use either to test the one-button mode. Note that button A and button B control different actuators; button C is disabled and button D nullifies auto-closing.

Press	Button A	Actuator
1 st	Opens the gate.	2 nd
2 nd	Stops the opening gate.	2 nd
3 rd	Closes the gate.	2 nd
4 th	Stops the closing gate.	2 nd

Press	Button B	Actuator
1 st	Opens the gate.	2 nd
2 nd	Stops the opening gate.	2 nd
3 rd	Closes the gate.	2 nd
4 th	Stops the closing gate.	2 nd
5 th	Opens the gate.	1 st
6 th	Stops the opening gate.	1 st
7 th	Closes the gate.	1 st
8 th	Stops the closing gate.	1 st

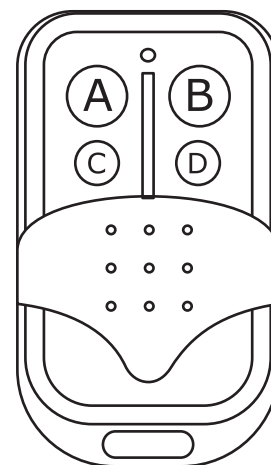

1. Toggle the rocker switch on the circuit board to “—”.

You should hear a short beep and the state indicator lights up and glows steady red.

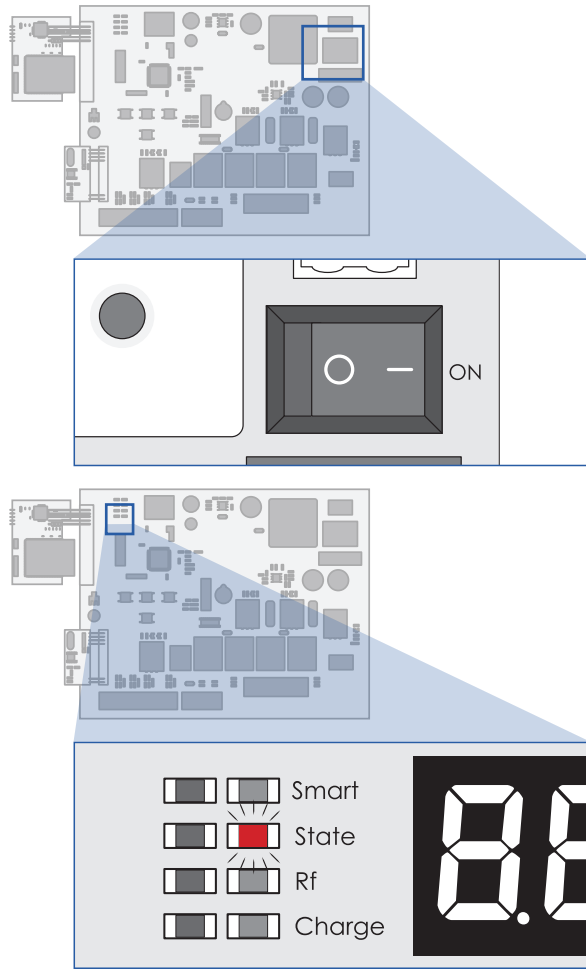

2. Press the first button to the left of the remote.

3. Check that the gate leaf attached to the 2nd actuator will move in the way as listed in the table.

Press	Button A	Actuator
1 st	Opens the gate.	2 nd
2 nd	Stops the opening gate.	2 nd
3 rd	Closes the gate.	2 nd
4 th	Stops the closing gate.	2 nd

4. (Dual-Actuators Only) Press the first button to the right of the remote.

5. (Dual-Actuators Only) Check that the gate leaves attached to the 2nd actuator and 1st actuator will move in the way as listed in the table.

Press	Button B	Actuator
1 st	Opens the gate.	2 nd
2 nd	Stops the opening gate.	2 nd
3 rd	Closes the gate.	2 nd
4 th	Stops the closing gate.	2 nd
5 th	Opens the gate.	1 st
6 th	Stops the opening gate.	1 st
7 th	Closes the gate.	1 st
8 th	Stops the closing gate.	1 st

Setting the Obstruction Sensitivity

Warning

- Clear any obstruction that is in or might come across the moving path of the gate and actuators before testing.
- Check that the obstruction sensitivity is well-adjusted to your needs. **DO NOT** skip this step, as a wrongly set obstruction sensitivity can cause fatal entrapment.

The actuators are so designed that they control the gate leaves to move fast upon receiving signal from a paired remote control and slow the leaves down when reaching the fully open/closed position.

Because of the difference in speed, the obstruction sensitivity has to be separately configured for the high speed and low speed phases of the travelling gate leaves.

Actuator 1 (high-speed phase)

1. Put a chair in the middle of the moving path of the gate leaf.
2. Press the first button to the left on the remote.

The gate should start opening and moving toward the chair.

If the gate has been stopped by the chair, then the obstruction sensitivity does not need adjustment.

If the gate has knocked down the chair and is pushing it on the ground,

- a. Toggle the rocker switch on the circuit board to “-” if it is not.

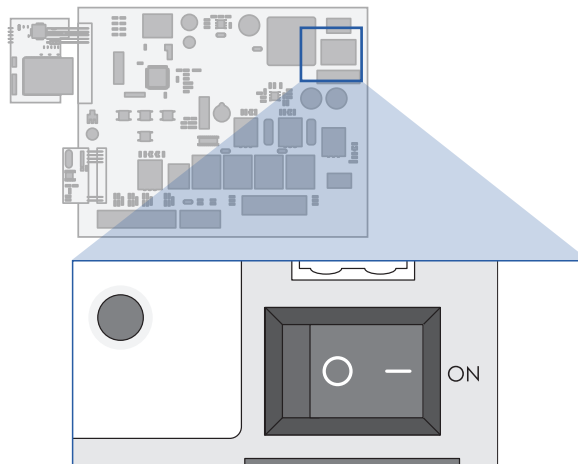

- b. Hold **Func** until the display reads **P0**.

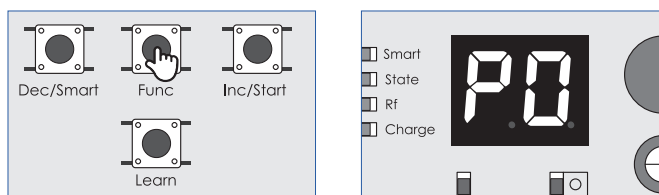

- c. Press **Inc/Start** until the display reads **P1**. Use **Dec/Smart** if you feel like pressing more.

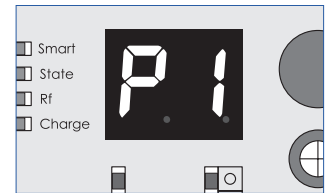

Note

Parameter P1 sets the high-speed obstruction sensitivity of the 1st actuator. The higher the value, the harder the actuator will push against an obstruction.

- d. Press **Func** and the display reads 10.
- e. Use **Dec/Smart** to decrease the value.
- f. Press **Func** to save the change and exit the current submenu.
- g. Reset the chair and repeat Step 2 and all its sub-steps **until the gate stops upon contacting the chair.**



Actuator 1 (low-speed phase)

1. Put a chair near the maximal open position of the gate leaf.
2. Press the first button to the left on the remote.

The gate should start moving and nearing the chair.

If the gate has been stopped by the chair, then the obstruction sensitivity does not need adjustment.

If the gate has knocked down the chair and is pressing it against another firm object,

- a. Toggle the rocker switch on the circuit board to “—” if it is not.

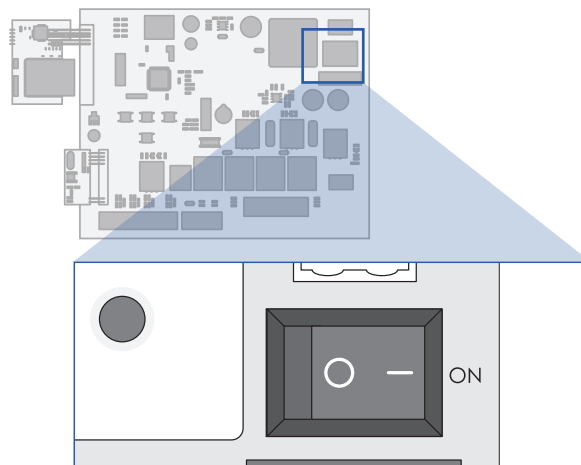

- b. Hold **Func** until the display reads **P0**.

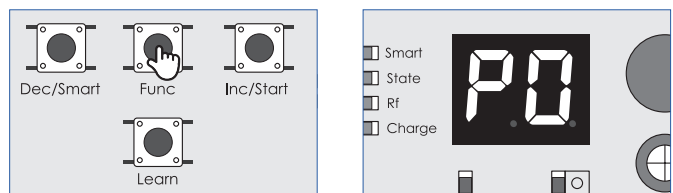

- c. Press **Func** again and the display reads **10**.

Note

Parameter P0 sets the low-speed obstruction sensitivity of the 1st actuator. The higher the value, the harder the actuator will push against an obstruction.

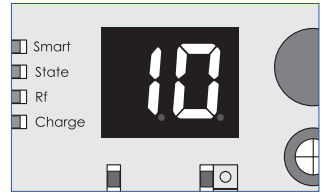

- d. Use **Dec/Smart** to decrease the value.
- e. Press **Func** to save the change and exit the current submenu.
- f. Reset the chair and repeat Step 2 and all its sub-steps until the gate stops upon contacting the chair.

Actuator 2 (high-speed phase)

1. Put a chair in the middle of the moving path of the gate leaf.
2. Press the first button to the left on the remote.

The gate should start opening and moving toward the chair.

If the gate has been stopped by the chair, then the obstruction sensitivity does not need adjustment.

If the gate has knocked down the chair and is pushing it on the ground,

- a. Toggle the rocker switch on the circuit board to “-” if it is not.

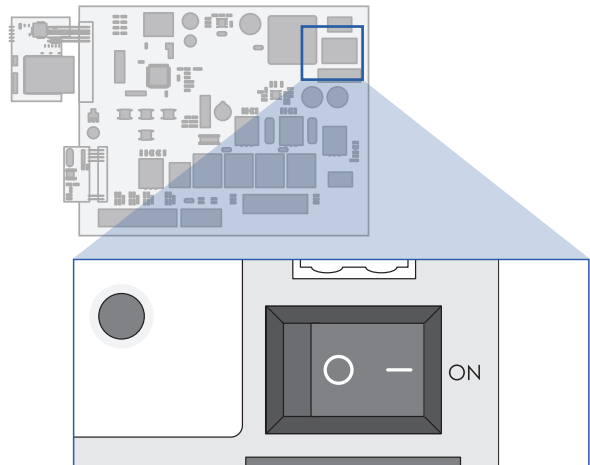

- b. Hold **Func** until the display reads **P0**.

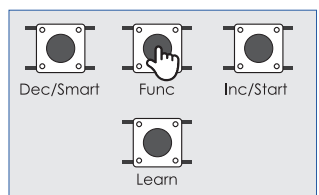

- c. Press **Inc/Start** until the display reads **P3**. Use **Dec/Smart** if you feel like pressing more.



- d. Press **Func** and the display reads **10**.

Note

Parameter P3 sets the high-speed obstruction sensitivity of the 2nd actuator. The higher the value, the harder the actuator will push against an obstruction.

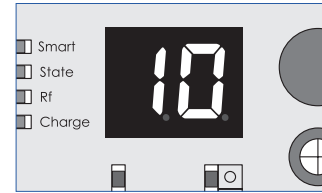

- e. Use **Dec/Smart** to decrease the value.
- f. Press **Func** to save the change and exit the current submenu.
- g. Reset the chair and repeat Step 2 and all its sub-steps until the gate stops upon contacting the chair.

Actuator 2 (low-speed phase)

1. Put a chair near the maximal open position of the gate leaf.
2. Press the first button to the left on the remote.

The gate should start moving and nearing the chair.

If the gate has been stopped by the chair, then the obstruction sensitivity does not need adjustment.

If the gate has knocked down the chair and is pressing it against another firm object,

- a. Toggle the rocker switch on the circuit board to “—” if it is not.

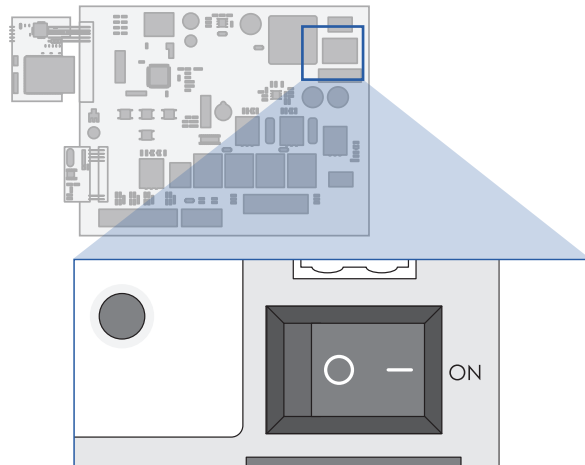

- b. Hold **Func** until the display reads **P0**.

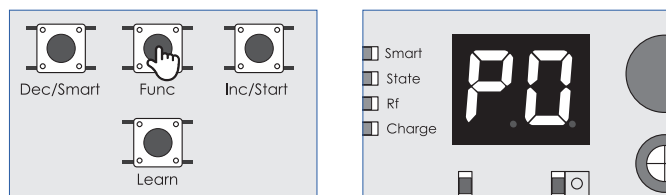

- c. Press **Inc/Start** until the display reads **P2**. Use **Dec/Smart** if you feel like pressing more.

Note

Parameter P2 sets the low-speed obstruction sensitivity of the 2nd actuator. The higher the value, the harder the actuator will push against an obstruction.

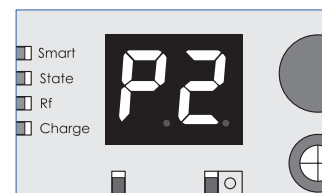

- d. Press **Func** again and the display reads **10**.
- e. Use **Dec/Smart** to decrease the value.
- f. Press **Func** to save the change and exit the current submenu.
- g. Reset the chair and repeat Step 2 and all its sub-steps until the gate stops upon contacting the chair.

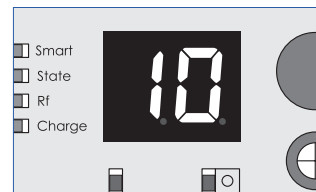

Setting Opening/Closing Delay

Opening Delay

1. Toggle the rocker switch on the circuit board to “—” if it is not.

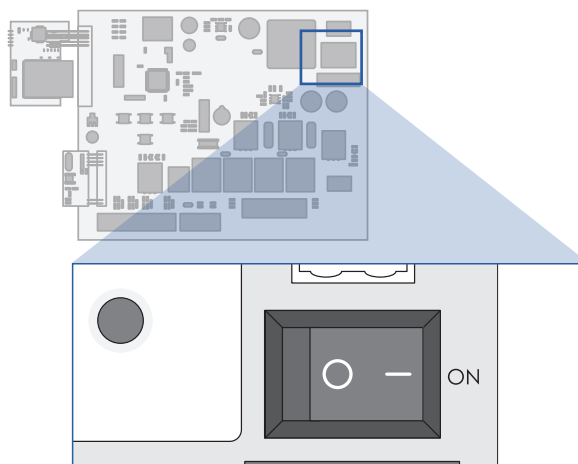

2. Hold **Func** until the display reads **P0**.

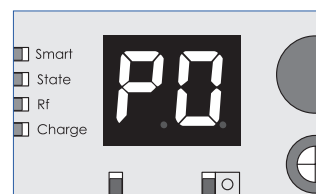
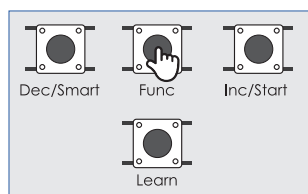

3. Press **Inc/Start** until the display reads **P7**. Use **Dec/Smart** if you feel like pressing more.

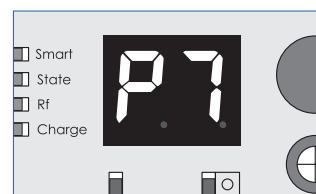

4. Press **Func** again and the display reads **02**.
5. Use **Dec/Smart** to decrease the value.
6. Press **Func** to save the change and exit the current submenu.



Note

- Parameter P7 sets the gate opening delay. Its value is modifiable within 0–15 seconds, with 0 meaning that the gate starts moving upon receiving a signal to open from a paired remote; 15 meaning the gate will start moving 15 seconds after receiving a signal to open.
- Customize the delay as you will need it to be.

Closing Delay

1. Toggle the rocker switch on the circuit board to “—” if it is not.

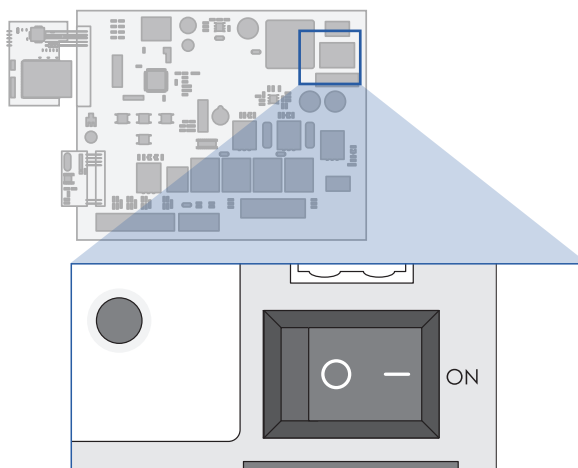

2. Hold **Func** until the display reads **P0**.

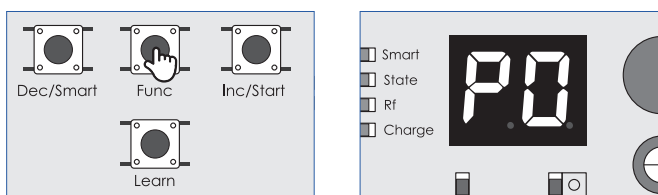

3. Press **Inc/Start** until the display reads **P8**. Use **Dec/Smart** if you feel like pressing more.

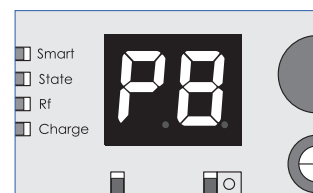

4. Press **Func** again and the display reads **02**.
5. Use **Dec/Smart** to decrease the value.
6. Press **Func** to save the change and exit the current submenu.

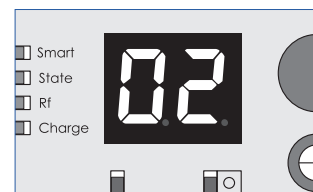

Note

- Parameter P8 sets the gate opening delay. Its value is modifiable within 0–15 seconds, with 0 meaning that the gate starts moving upon receiving a signal to close from a paired remote; 15 meaning the gate will start moving 15 seconds after receiving a signal to close.
- Customize the delay as you will need it to be.

Auto-Closing Delay

1. Toggle the rocker switch on the circuit board to “—” if it is not.

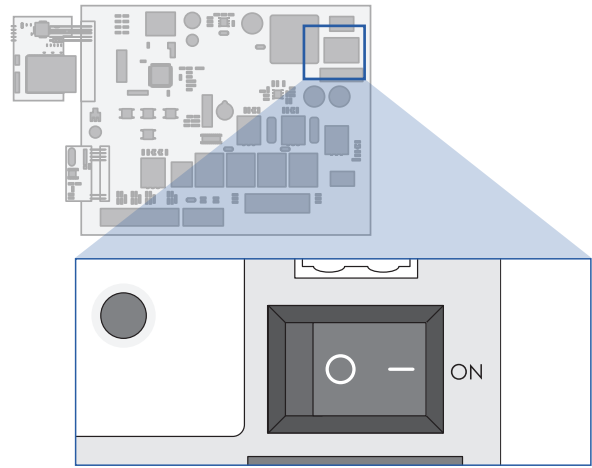

2. Hold **Func** until the display reads **P0**.

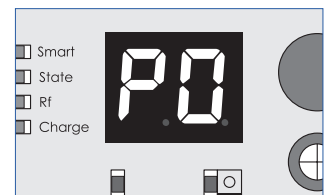
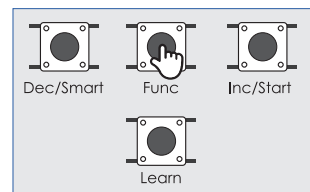

3. Press **Inc/Start** until the display reads **P9**. Use **Dec/Smart** if you feel like pressing more.



4. Press **Func** again and the display reads **00**.

5. Use **Dec/Smart** to decrease the value.

6. Press **Func** to save the change and exit the current submenu.

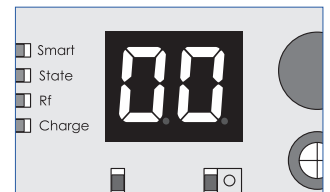

Note

- Parameter P9 sets the delay to close when the gate has reached the max. opening position. Its value is modifiable within 0–99 seconds, with 0 meaning that the gate starts closing upon reaching its max. opening position; 99 meaning the gate will wait for 99 seconds after reaching the max. opening position and start closing after that duration of time.
- Customize the delay as you will need it to be. But keep in mind that setting it to 0 or another short duration of time could cause entrapment. **ALWAYS** test all your vehicles with this time duration.
- Pressing button D ONLY cancels the auto-closing for once. The preset auto-closing delay will resume once the gate reaches the max. opening position.

Remote Control

Pairing

1. Toggle the rocker switch on the circuit board to “—”.

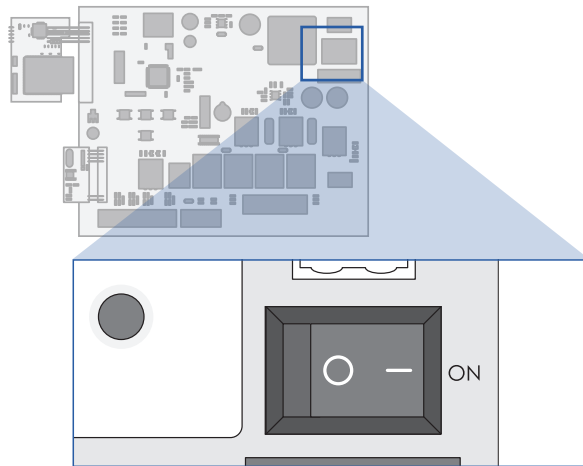

Indicator light **State** comes on.

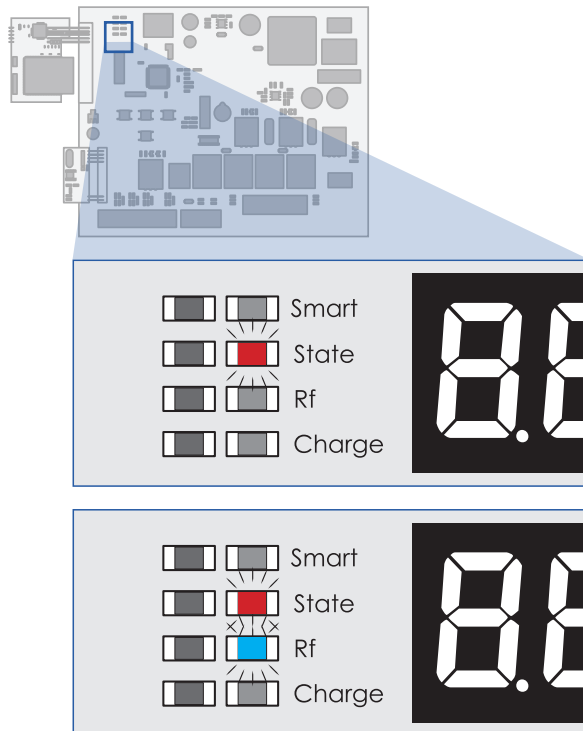

2. Press **Learn**.

Rf indicator instantly comes on and the buzzer sounds a beep.

3. Press any button on your remote.

If the remote is compatible, another beep should instantly sound. Meantime, the display should show a one or two-digit number, indicating the number of remotes paired to the circuit board and that the remote has been successfully paired.

Note

- The segment display has only two digits, but the circuit board has a capacity of up to 120 remotes paired.
- Because of that, if over a 100 (but within 110) remotes have been paired, the first two digits will be replaced by “AA”; if over 110 remotes have been paired, then the first two digits will be replaced by “BB”.
- If the circuit board has been fully paired, the display reads “---”.
- If no remote button is pressed within 8 seconds after Learn being pressed, the control board will automatically exit the pairing.

Unpairing

Caution

- **DO NOT** do the unpairing unless it is really necessary to do so.
- These procedures purge ALL paired remotes.

Hold **Learn** until you hear a long beep and the display shows **00**, indicating all paired remotes have been unpaired with the circuit board.

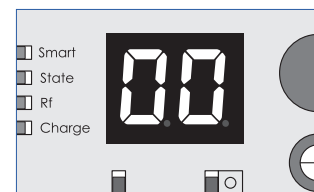

3.4.11 Display Parameters and Message Codes

This 2-digit segment display can show up to 20 parameters and 24 working status codes. Refer to the tables below for their meanings and way to adjust.

Message Codes

Below are the message codes that will show up when the actuator operates.

Message Codes	Meanings
OP	Shows up when actuator 1 starts opening the gate.
OP.	Shows up when actuator 2 starts opening the gate.
O.P.	Shows up when actuator 1 and 2 start opening the gate.
CL	Shows up when actuator 1 starts closing the gate.
CL.	Shows up when actuator 2 starts closing the gate.
C.L.	Shows up when actuator 1 and 2 start closing the gate.
--	Shows up when actuator 1 has moved to its max. opening or closing position.
--.	Shows up when actuator 2 has moved to its max. opening or closing position.
--.	Shows up when actuators 1 and 2 have moved to their max. opening or closing position.
OH	Shows up when actuator 1 has met an obstruction during high-speed phase.
OH.	Shows up when actuator 2 has met an obstruction during high-speed phase.
O.H.	Shows up when actuators 1 and 2 have met an obstruction during high-speed phase.
OL	Shows up when actuator 1 has met an obstruction during low-speed phase.
OL.	Shows up when actuator 2 has met an obstruction during low-speed phase.
O.L.	Shows up when actuators 1 and 2 have met an obstruction during low-speed phase.

Message Codes	Meanings
EC*	Shows up when the overload protection of actuator 1 has been tripped.
EC.*	Shows up when the overload protection of actuator 2 has been tripped.
E.C.*	Shows up when the overload protection of actuator 1 and 2 have been tripped.
PH	Shows up when the IR sensor has been triggered.
L0	Shows up when actuator 1 has reached its max. opening position.
L0.	Shows up when actuator 2 has reached its max. opening position.
LC	Shows up when actuator 1 has reached its max. closing position.
LC.	Shows up when actuator 2 has reached its max. closing position.
Lb	Shows up when the battery is running out.









Note







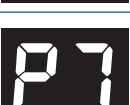



*Both actuators trigger their overload protection after 60 seconds of continuous running. The overload protection of also trips If the low-speed phase exceeds 30 seconds.

Parameters

All the parameters can be accessed through the following steps.

1. Hold **Func** until **P0** shows up.
2. Use **Inc/Start** or **Dec/Smart** to toggle through the parameter menu.
3. Stop when you see the parameter whose value needs adjusting.
4. Press **Func** to enter the parameter submenu, where the value of the parameter is shown.
5. Use **Inc/Start** or **Dec/Smart** to change the value.
6. Press **Func** to save the change. You should hear a short beep if the change was successful.
7. Press **Learn** to exit the parameter menus and turn off the display.

Parameters	Value Ranges	Defaults	Meaning
	0-20	10	Sets the obstruction sensitivity of actuator 1 during low-speed phase. The higher the value, the harder the actuator will push against obstruction.
	0-20	10	Sets the obstruction sensitivity of actuator 1 during high-speed phase. The higher the value, the harder the actuator will push against obstruction.
	0-20	10	Sets the obstruction sensitivity of actuator 2 during low-speed phase. The higher the value, the harder the actuator will push against obstruction.
	0-20	10	Sets the obstruction sensitivity of actuator 2 during high-speed phase. The higher the value, the harder the actuator will push against obstruction.
	3-30	10	Sets the duration of the high-speed phase of actuator 1.
	3-30	10	Sets the duration of the high-speed phase of actuator 2.
	0-99	10	Sets the auto-closing delay activated by a card. To disable this parameter, set the value to 0.
	0-15	2	Sets the opening delay. To disable this parameter, set the value to 0.
	0-15	2	Sets the closing delay. To disable this parameter, set the value to 0.
	0-99	0	Sets the auto-closing delay. To disable this parameter, set the value to 0.

Parameters	Value Ranges	Defaults	Meaning
	0-1	0	Sets the status of an alarm lamp. 1: Keeps the alarm lamp on while the gate is moving. Turns it off when the gate stops. 0: Keeps the alarm lamp on while the gate is moving. Turns it off after the gate has stopped for 30 seconds.
	0-5	0	Sets the functioning time of the electric lock. 0: Turns the electric lock off.
	0-1	1	Sets the work mode of the electric lock. 0: Means the electric lock remains energized and locked all the time except when opened by cutting off the circuit. 1: Means the electric lock remains unenergized and locked all the time except when opened by a closing the circuit.
	0-3	0	Controls the 2Side terminal. 0: Sets the device connected to the terminal to repetitively control actuators 1 and 2 in such an order: open>stop>close>stop . 1: Sets the device connected to ONLY open the gate(s). 2: Sets the device connected to ONLY close the gate(s). 3: Disables this terminal.
	0-3	0	Controls the 1Side terminal. 0: Sets the device connected to the terminal to repetitively control actuator 2 in such an order: open>stop>close>stop . 1: Sets the device connected to ONLY open the gate(s). 2: Sets the device connected to ONLY close the gate(s). 3: Disables this terminal.
	0-1	1	Sets the work mode of the IR sensors. 0: NC. 1: NO.
	0-1	0	Sets the number of the actuator controlled. 0: Dual actuator 1: Single actuator
	0-10	6	Sets the duration of the low-speed phase.
	0-1	0	Sets the way the circuit board perceives a limit stop. 0: Mechanical limit stop 1: Electric limit stop
	0-10	0	Resets the value of a selected parameter among P0-P9, with 1 referring to P0 and 10 to P9.

4 USING THE APP

Warning

- The QR code of the gate opener is **UNIQUE** to each device. Scan the QR code on the control box to connect to your device.
- The operation process may vary depending on the software updates.
- If the language displayed when you open the app is not the language you want, refer to the **4.6.1 Settings** to change the language.
- When connecting to the gate opener for the first time, make sure the opener and the mobile device to be connected are in the same local area network.
- If you need a hotspot to connect to the opener, the mobile device and gate opener to be connected need to be in the same hotspot of another mobile phone. The hotspot turned on by the mobile device that needs to be connected is invalid.

4.1 Log In

1. Download and launch the app.

You can download zumi app in the Apple Store or Google Play.

The default page is the password login, which offers several login options. But now, you need to create an account first.

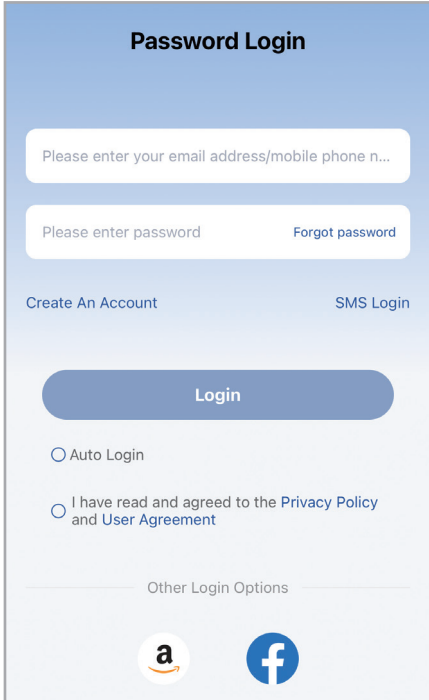

2. Tap **Create An Account** button to go to the account creation page.

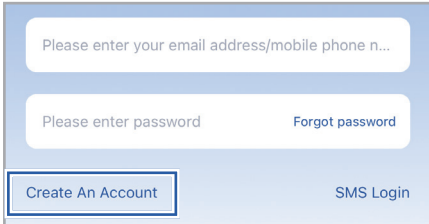

3. Enter your username and contact information, and then tap **Send** button to receive the verification code.

Please enter user name

Please enter your email address/mobile phone n...

Please enter verification code **Send**

Please enter a password of 6-12 characters, incl...

Please fill in new password again.

4. Enter the verification code and password, then confirm the password by re-entering it. Tap **Register and log in** button.

Note

Tap the checkbox to agree to the Privacy Policy and User Agreement; otherwise, you will not be able to use this app and its provided services.

Please fill in new password again.

Register and log in

I have read and agreed to the Privacy Policy and User Agreement

4.2 Adding a Device

4.2.1 Adding a Device via QR Code

1. Tap **Add device** button from the Homepage.

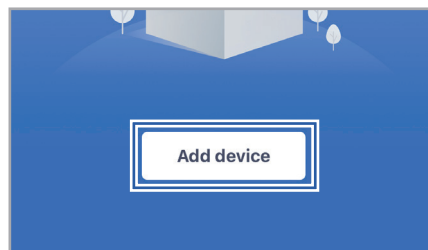

2. Use the scan icon at the upper right corner to scan the QR code on the control box to connect to the device.

If you have taken a photo of the QR code before and have it stored in your phone library, just tap the **Photo Library** button at the lower left corner and select the photo of the QR code.

Note

The scanning will ask for permission to use your camera. Just permit it.

3. After the device has been connected, you can control it via the app.

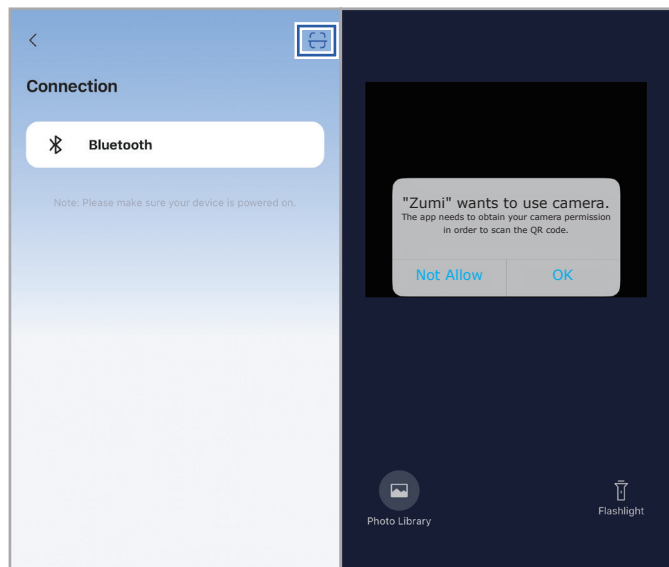

4.2.2 Adding a Device via Bluetooth

1. Tap **Add device** button from the Homepage.
2. Tap **Bluetooth** and allow the app to use the Bluetooth function of your phone.

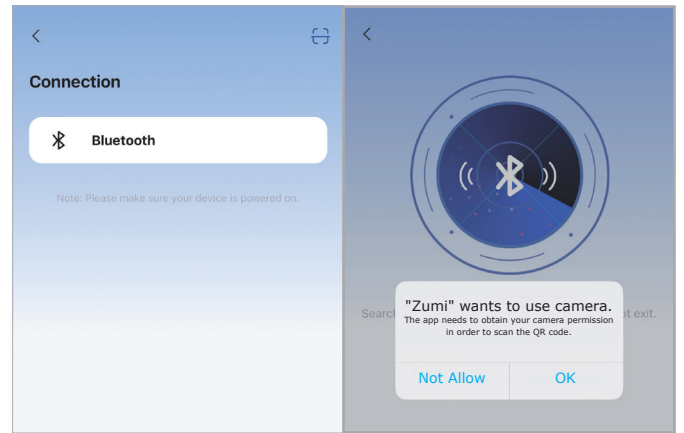

3. The app will automatically start searching for nearby connectable devices.

Note

Be careful not to exit the interface during the search process.

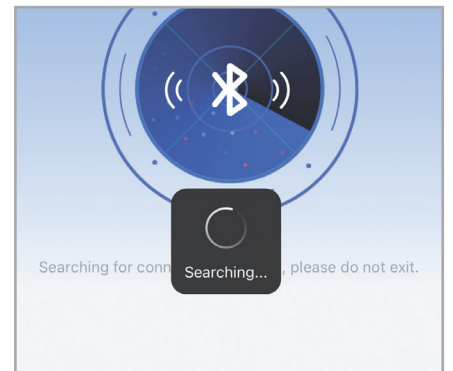

4. After the device has been connected, you can control the opener via the app.

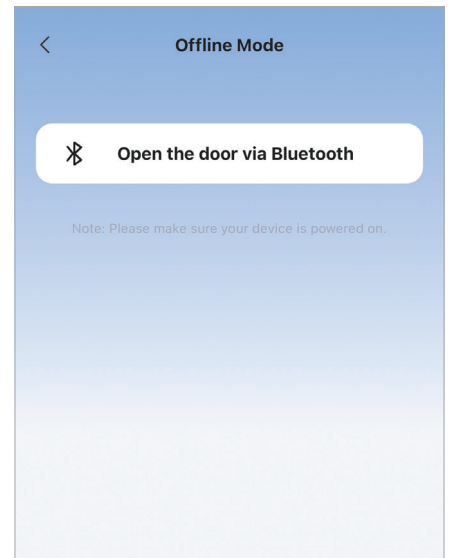

4.3 Managing Members and Devices

You can group members and devices and manage them separately.

1. Tap **Create account** button.

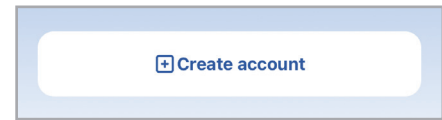

2. Enter the group name and then tap **Add device** button.

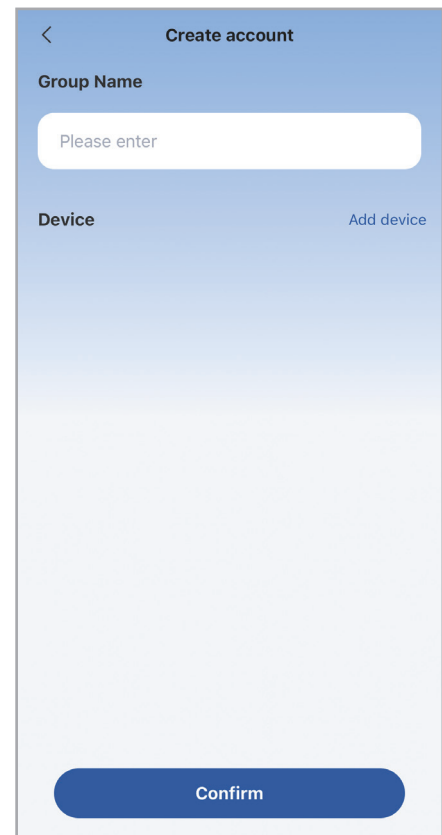

3. Select the device that has been connected in **4.2 Adding Device**, and then tap **Confirm** to save.

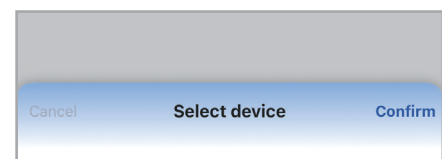

4. Tap **Invite member** and invite member via e-mail or message.

Invitees can join the group via the link sent.

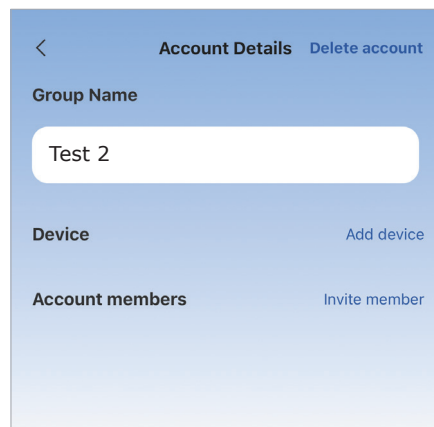

5. Assign permissions to members as needed and tap **Save** to save the changes.

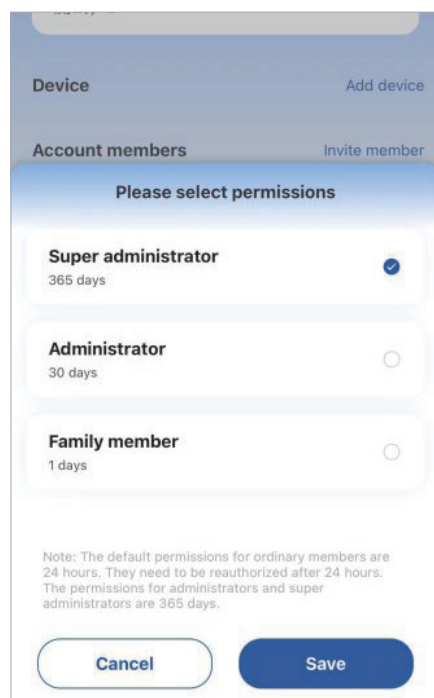

4.4 Setting Up Intelligent Scene

You can set up intelligent scenes as needed.

1. Tap **Intelligent Scene** and add intelligent scenes.

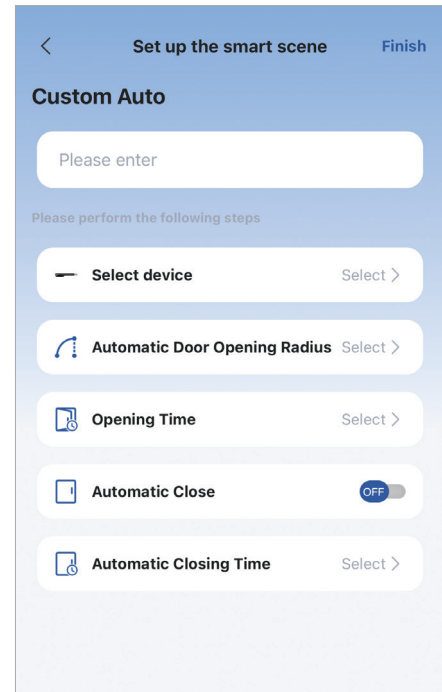

2. Set a name for the intelligent scene, such as Scene 1.

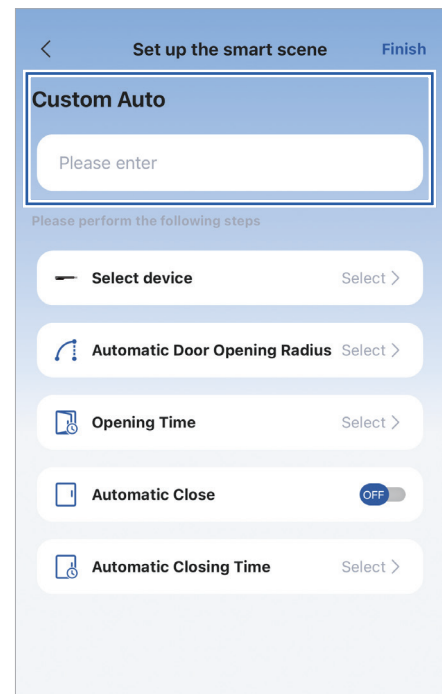

3. Select the device that is already connected and needs to be added to the intelligent scene.

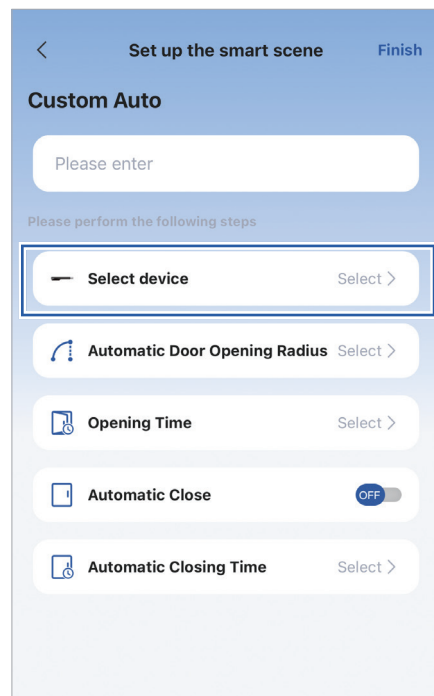

4. Select opening radius and opening time according to your needs.

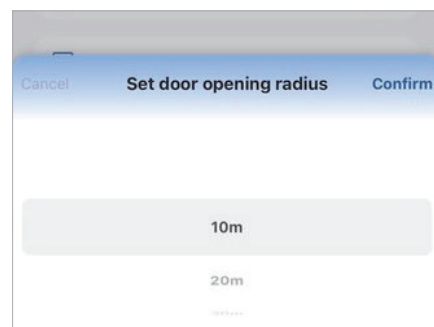
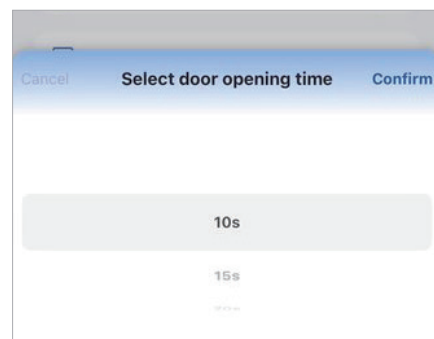
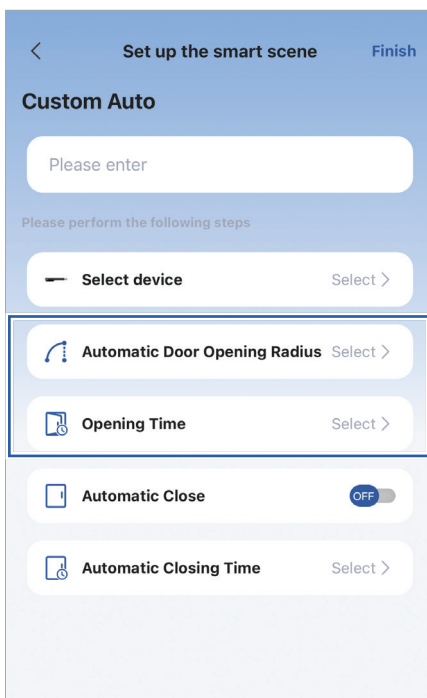

5. (Optional) Enable **Automatic Close** and select closing time.

Note

If the automatic close is disabled, the closing time is not selectable.

6. After all parameters are set, tap **Finish** in the upper right corner, and you will be automatically directed to the intelligent scene interface.

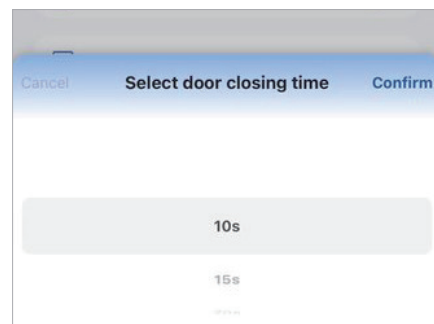

4.5 Viewing Gate Opening and Closing Records

Tap **History** button to view the records.

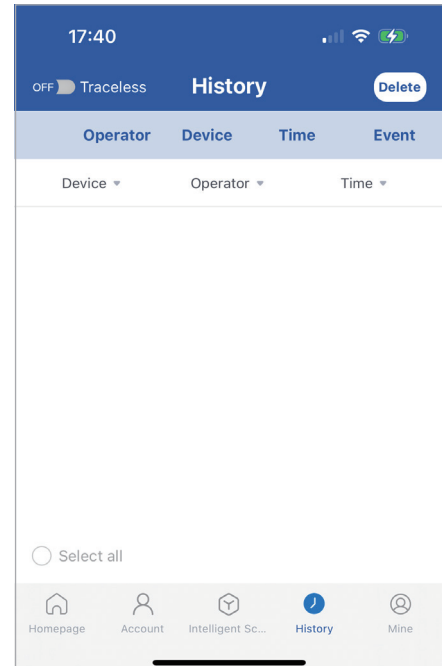

Filter

You can filter the history by device, operator and time to view the records.

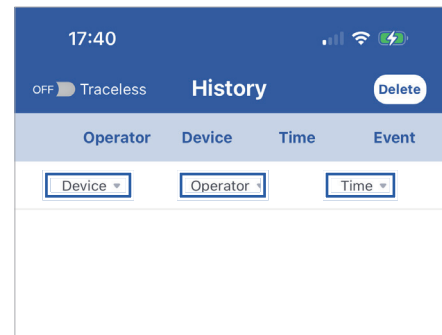

Delete

You can select a record and tap **Delete** at the upper right corner to delete it.

If you want to delete all the records, tap **Select all** and then tap **Delete**.

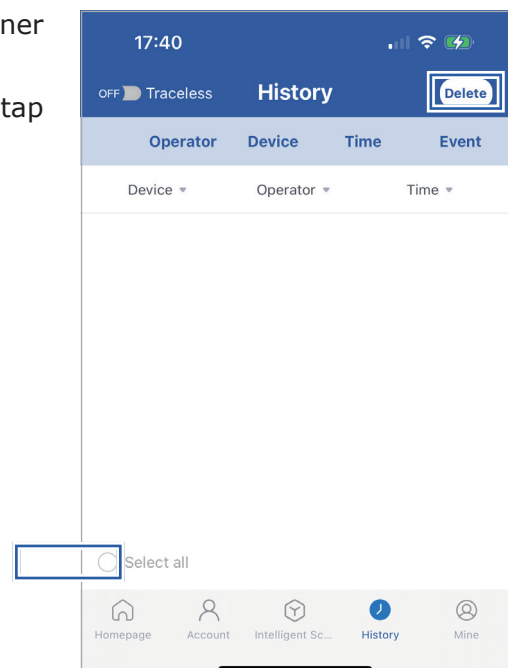

Traceless

If you want to fly under the radar, just enable the **Traceless** function.

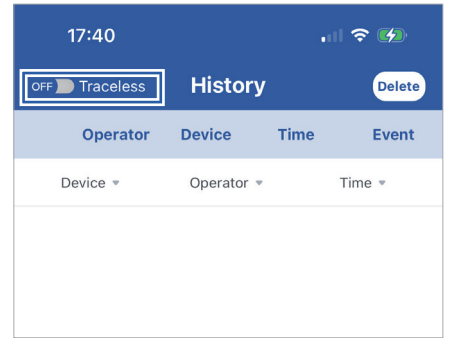

4.6 Others

4.6.1 Settings

Tap the gear icon in the upper right corner to enter the settings interface

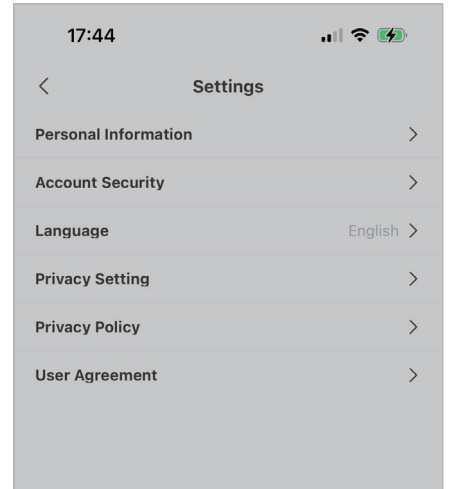

Personal Information

You can set your basic information on this page.

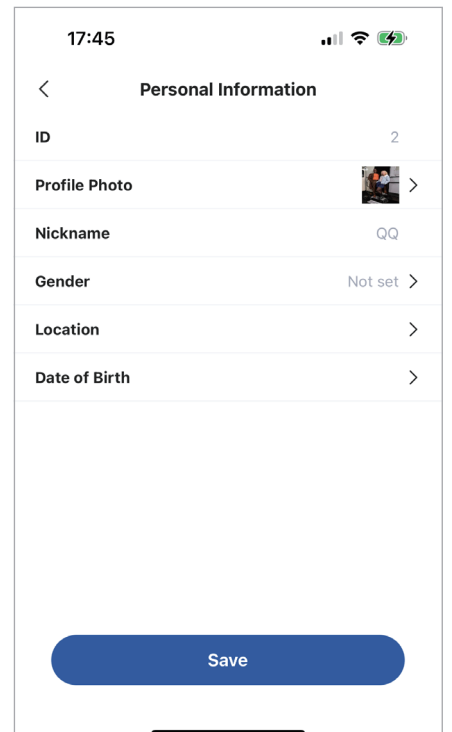

Account Security

You can bind your account, change your password, and terminate your account on this page.

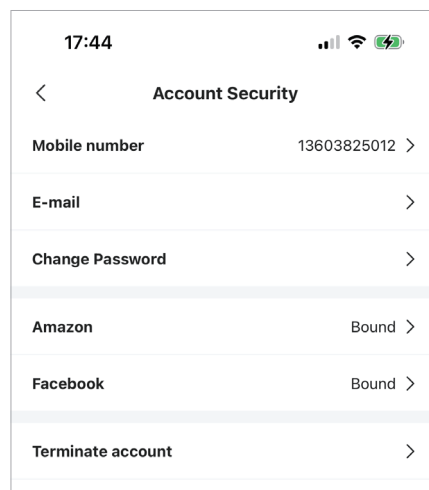

Language

Select the language according to your needs.

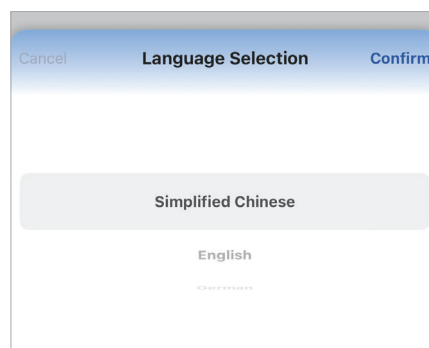

Privacy Setting

Authorize APP notification permissions, etc. on this page. You can also authorize all permissions required by APP with one-click authorization in the upper right corner.

Privacy Policy

View the privacy policy here.

User Agreement

View the user agreement here.

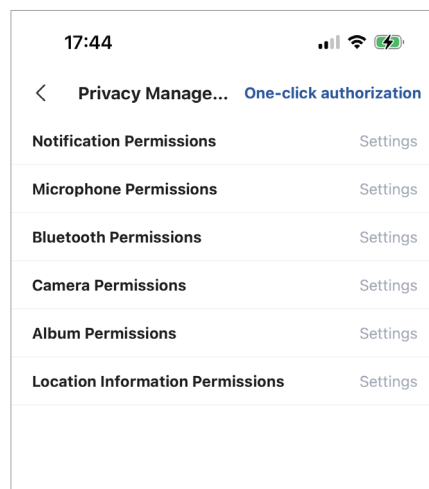

4.6.2 Information & Feedback

You can use and learn about the app and other services provided in the **Mine** interface.

Message Center

You can receive notifications from the system here.

Instruction & Video Guide

Get the instructions and installation video here.

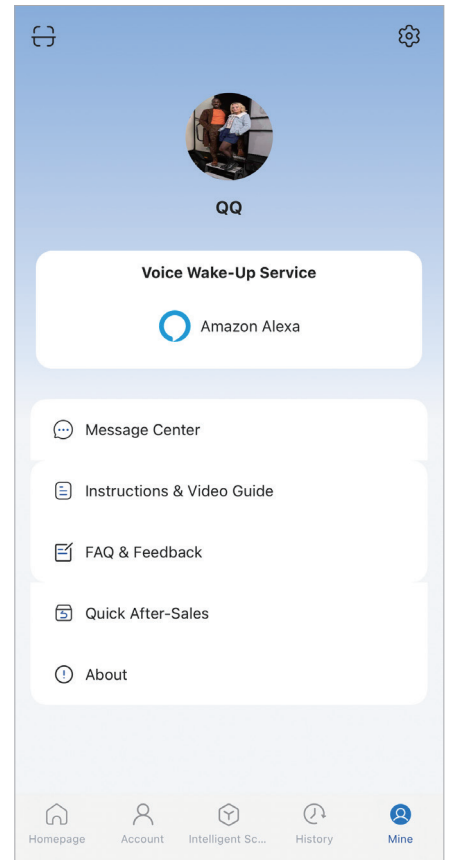

FAQ & Feedback

Here are some solutions to common problems. If you have any questions, you can send us feedback here.

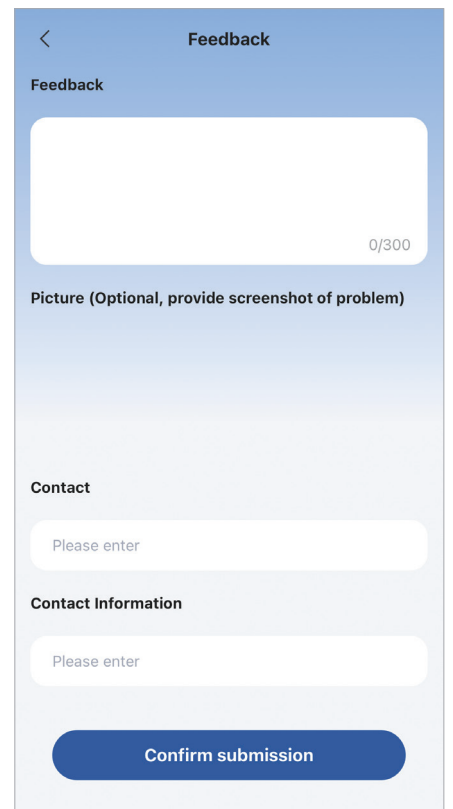

Quick After-Sales

You can communicate with customer service here to get fast after-sales service.

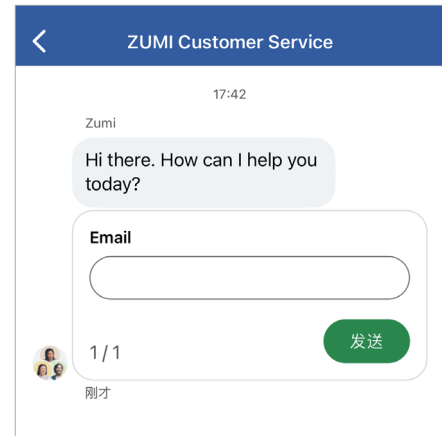

About

Learn about the company and software version information, and upload the log.

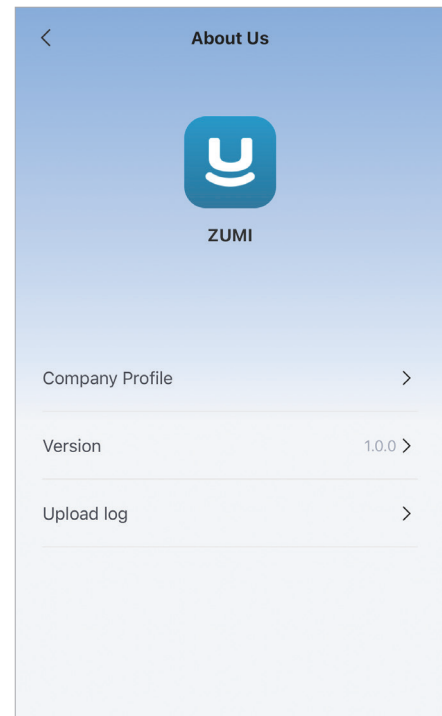

5 MAINTENANCE

Parts and Schedules

Warning

- **ALWAYS** replace broken components with identical ones.
- **ONLY** allow any maintenance to be done by a certified technician.
- Limit access to the gate when maintenance is under way.
- **ALWAYS** test the functionality of all accessories and components before resuming use.

Caution

ALWAYS wear personal protective equipment sufficient for the task at hand.

Parts		Tasks	Schedule	
			Monthly	Every 6 Months
Accessories	IR Sensor	Check and test for proper operation.	✓	
	Batteries		✓	
	Solar Panel		✓	
Electrical	All Connections	Check all for loosened connection(s).		✓
Hardware	Rear Bracket	Check for looseness or rust.	✓	
	Front Bracket	Check for rounding up of the pivot.	✓	
	Fasteners	Check all for looseness.		✓
	Gate	Check for wear or damage.	✓	
Warning Signs		Check for illegibility.	✓	

Note

- Shorten the maintenance schedule if the actuators have been in use for heavy-duty purpose or its surround environment may entail this.
- Check the front bracket pivot for signs of rounding up if you have tightened the square bolt all the way down but it still fails to grip the front bracket pivot.

6 TROUBLESHOOTING

Warning

- Leave any issue not found in the table below to a trained technician. Some issues, whose solution starts with "Have a certified electrician..." are also exclusive to technicians.
- **ALWAYS** cut the power by disconnecting the circuit board from its power source.

Possible Problems	Usual Solutions
The gate does not open or close normally and no indicator lights activate on the circuit board.	Verify that the power supply is functioning properly.
	Check that the fuse is not blown.
	Have a certified electrician rewire your system.
The door opens but does not close.	Remove any obstacles which might be in the gate's path.
The remote control is not working.	Change the remote control's battery.
	Pair the remote control to the board again.
	Remove any obstruction between the motor and the remote.
The actuator wobbles when activated.	Tighten the front and rear brackets.
The circuit breaker trips repeatedly.	Have a certified electrician check the power supply line and motor line for short circuits. Repair if necessary.
The gate suddenly stops or reverses when moving.	Remove any obstacles which might be in the gate's path.

7 DISPOSAL

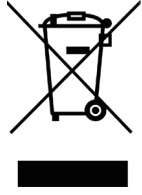

Electrical products should not be disposed of with household products. In the EU and UK, according to the European Directive 2012/19/EU for the disposal of electrical and electronic equipment and its implementation in national laws, used electrical products must be collected separately and disposed of at the collection points provided for this purpose. Locations in Australia, Canada, and the United States may have similar regulations. Contact your local authorities or dealer for disposal and recycling advice.



CONTACT US

Thank you for choosing our products! If you have any questions or comments, contact us at **contact@cssupportgroup.com** and we'll resolve your issue ASAP!

For a .pdf copy of the latest version of these instructions, use the appropriate app on your smartphone to scan the QR code to the right.



WS2 SWING GATE OPENER USER MANUAL

SGO-ZUMI-04

Rev. 24 Jun. 2024