

## Contact Us

Thank you for choosing our products! If you have any questions or comments, contact us at [support@viribusbikes.com](mailto:support@viribusbikes.com) and we'll resolve your issue ASAP!

For a .pdf copy of the latest version of these instructions, use the appropriate app on your smartphone to scan the QR code.



# Electric Tricycle

## User Manual

Read Carefully Before Use  
Keep for Future Reference



# Disclaimer

Read this disclaimer completely and carefully before proceeding with the rest of the manual content.

## 1. **As-Is**

This Viribus product is sold 'as is' and without any express or implied warranties, including but not limited to the implied warranties of merchantability and fitness for a particular purpose.

## 2. **Product Modifications**

Any modifications or alterations to Viribus products void any warranties and may result in damage or injury. Viribus shall not be liable for any damages resulting from such modifications or alterations.

## 3. **Compliance with Laws**

Customers shall be liable for ensuring that the use of Viribus products complies with all applicable laws and regulations in their respective jurisdictions. Viribus assumes no responsibility for any violations of laws or regulations resulting from the use of Viribus products.

## 4. **Correct Use**

Always use Viribus products only as directed in the accompanying manuals. Failure to follow instructions may result in injury or damage.

Always ensure the assembly, installation, operation, maintenance, or repair of Viribus products is carried out by a competent person.

Always make maintenance regularly throughout Viribus products' lifecycles; you have the liability to keep the products operating as intended.

Always wear appropriate protective gear.

## 5. **Third-Party Products**

Viribus shall not be liable for any damages or losses resulting from the use of third-party products in conjunction with Viribus products. Customers shall refer to the third-party's guidelines or/and warranties (if any) for any third-party products used.

## 6. **Limitation of Liability**

Viribus shall not be liable for any direct, indirect, punitive, incidental, special, or consequential damages to property or life, whatsoever arising out of or connected with the use or misuse of Viribus products. In no event shall Viribus's liability exceed the value of the products sold.

This disclaimer states the entire obligation of Viribus with respect to Viribus products. If any part of this disclaimer is determined to be void, invalid, unenforceable, or illegal, including but not limited to the warranty disclaimers, liability disclaimers, and liability limitations set forth above, the invalid or unenforceable provision will be deemed superseded by a valid and enforceable provision that most closely matches the intent of the original provision and the remainder of the agreement shall remain in full force and effect.

# Contents

<b>1. Safety Information</b> .....	<b>1</b>	5.3 Throttle Control.....	35
1.1 General Notice.....	1	5.4 Pedal Assist Control.....	36
1.2 Traffic Rules.....	1	5.5 Cruise Control.....	36
1.3 Clothing.....	1	5.6 Push Assist Control.....	37
1.4 Safety Checks.....	2	5.7 Manual Control.....	37
1.5 Sensible Use.....	2	5.8 Navigation.....	38
1.6 Electronic Components.....	3	<b>6. User-Defined Parameter Menus</b> .....	<b>39</b>
<b>2. Product Diagram</b> .....	<b>4</b>	6.1 General Guide.....	39
2.1 Overview.....	4	6.2 Display Brightness.....	41
2.2 Package Contents.....	5	6.3 Measurement Units.....	41
2.3 Handlebars.....	7	6.4 Timed Shutoff.....	41
2.4 Display Panel.....	8	6.5 Wheel Diameter.....	41
<b>3. Specifications</b> .....	<b>9</b>	6.6 Speed Sensor.....	42
<b>4. Assembly</b> .....	<b>9</b>	6.7 Top Speed.....	42
4.1 Installing the Rear Wheels.....	10	6.8 Throttle Start.....	42
4.2 Installing the Handlebars.....	12	6.9 Disabling PAS or Throttle Control.....	42
4.3 Installing the Saddle.....	13	6.10 PAS Sensitivity.....	43
4.4 Connecting the Main and Rear Frames.....	14	6.11 PAS Acceleration.....	43
4.5 Installing the Short Chain.....	15	6.12 PAS Sensor.....	43
4.6 Installing the Front Fender, Stay, Brake Caliper, and Light.....	17	6.13 Resetting the Trip Odometer.....	43
4.7 Installing the Motorized Front Wheel.....	21	6.14 Fault History.....	44
4.8 Installing the Rear Reflectors.....	22	6.15 Bluetooth RSSI Level.....	44
4.9 Installing the Rear Fenders and Stays.....	22	6.16 Battery Voltage.....	46
4.10 Feeding the Rear Brake Cable.....	25	6.17 Disabling Cruise Control.....	44
4.11 Installing the Rear Basket.....	26	6.18 Menu Languages.....	44
4.12 Installing the Chain Guard.....	28	6.19 Password Protection.....	45
4.13 Installing the Pedals.....	29	6.20 Bluetooth Connection.....	47
4.14 Installing the Rear Wheel Caps.....	30	6.21 System Version.....	48
4.15 Installing the Front Reflector.....	30	6.22 Restoring the Factory Settings.....	48
4.16 Connecting the Wires.....	31	<b>7. Technician-Defined Issues</b> .....	<b>49</b>
4.17 Post-Assembly Actions.....	32	<b>8. Maintenance</b> .....	<b>50</b>
<b>5. Operation</b> .....	<b>33</b>	<b>9. Troubleshooting</b> .....	<b>51</b>
5.1 Charging.....	33	<b>10. Disposal</b> .....	<b>52</b>
5.2 Turning ON/OFF the Tricycle.....	35		



# 1. Safety Information

## Warning

### 1.1 General Notice

- Read **ALL** these instructions completely prior to assembly and use.  
Contact customer service if any point is unclear.
- Provide this manual to anyone who will use this tricycle and provide it with this tricycle (whether already assembled or not) if it is ever given or sold to a third party.
- **ONLY** assemble and use this tricycle in accordance with these instructions.  
Failure to do so may lead to serious property damage and severe personal injury.

### 1.2 Traffic Rules

- **ALWAYS** obey **ALL** applicable local and national laws and regulations while riding.
- **DO NOT** allow use by children, by persons unfamiliar with this tricycle or these instructions, or by anyone whose physical or mental impairment precludes safe use.
- **DO NOT** ride this tricycle while tired or under the influence of drugs or medication.
- **DO NOT** ride this tricycle in **ANY** area prohibited to electric tricycles.
- **ALWAYS** maintain your reflectors and other required safety equipment.
- It is advisable to equip your tricycle with a warning device such as a horn, bell, and light in case you are riding at times of poor visibility.  
This is **EVEN** required in some jurisdictions.

### 1.3 Clothing

- **ALWAYS** wear appropriate hand protection during assembly, disassembly, adjustment, or repair of this tricycle.
- **DO NOT** wear loose footwear or clothing that may become caught in the wheels or any other moving parts while riding.
- **DO NOT** ride this tricycle with bare feet.  
**ALWAYS** wear closed-toe shoes with good traction to maintain grip on the pedals and provide protection for your feet.
- **ALWAYS** wear a helmet and other required protective gear that meet safety standards while riding.
- Gloves with grip padding are strongly recommended for riding.  
They can strengthen your hold on the handlebars and protect your hands in case of a fall.
- Wear sunglasses or other clear protective eyewear to shield your eyes from dust, debris, and insects.
- In sunny conditions, it is advisable to apply sunscreen to exposed skin, especially for long rides.
- For best results, choose brightly colored or reflective clothing or attach reflective accessories or strips to your clothing to enhance visibility from all angles, especially during low-light conditions.

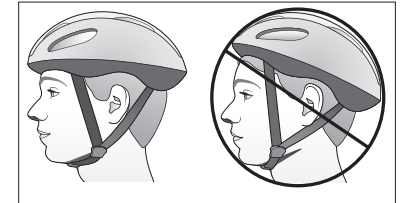

## 1.4 Safety Checks

- **ALWAYS** check that **BOTH** the front and rear brakes are positioned properly **BEFORE** riding.

Even when power is cut to the motor, the inertia of the tricycle will often require active braking power.

- **ALWAYS** check that **ALL** components and fasteners are intact and securely tightened **BEFORE** and **AFTER** riding.
- Regularly check the reflectors to make sure that they are clean, straight, unbroken, and securely mounted. Also perform this check for the front light.

Riding with low light or without lights or reflectors is **EXTREMELY** dangerous.

- **DO NOT** ride this tricycle if any part is damaged or shows any sign of malfunction.

Repair or replace worn and broken components before further use, especially bent or broken spokes and wheel rims.

- **NEVER** replace any components or fasteners with nonidentical ones.

## 1.5 Sensible Use

- **ONLY** allow one person to use this tricycle at a time.
- **DO NOT** carry children in the rear basket while riding.

If carrying pets, ensure that this act is permitted in your jurisdiction and they are safely secured with comfort.

- **NEVER** ride at a speed where your stopping distance exceeds your visibility.
- For optimal safety, it is **NOT** recommended to ride your tricycle at night or in environments with poor visibility (e.g., foggy or snowy conditions).

If you have an emergency that makes it necessary to do so, keep your light on and limit your speed appropriately.

- It is recommended that you **NOT** ride your tricycle fast **UNTIL** you are **FULLY** familiar with this new electric tricycle and its controls.

**HOWEVER**, even when you are familiar with the tricycle, **ALWAYS** be mindful of your speed, ensuring that you have sufficient room to brake in an emergency.

- **DO NOT** ride this tricycle in extreme weather conditions, such as thunderstorms and hurricanes.

If you meet with them during a ride, stop your tricycle, find a safe shelter, and wait until they pass.

- When meeting a strong wind, keep a firm grip on the handlebars, lean into the wind, and adjust your position as needed to maintain control.

- In wet weather, be careful to avoid sharp turns, which are easy to cause an accidental fall.

- **ALWAYS** be alert for people, animals, or any obstacles that may appear in front of you while riding your tricycle.

**ALWAYS** be careful of passing parked cars, whose doors might open suddenly.

**ALWAYS** be aware that pedestrians and drivers may not expect the speed or responsiveness of your tricycle. Adjust your behavior accordingly.

It is advisable to install warning devices to draw their attention, **BUT** always be ready to turn safely out of their way if needed.

- **ALWAYS** be careful at road and rail crossings.

Slow down and check both ways for oncoming traffic.

- **DO NOT** ride this tricycle in close proximity to precipices or on highly uneven, sandy, or sloped surfaces.



- **DO NOT** push backward on the pedals when using the gear shifter.  
Otherwise, the chain may get stuck, causing serious damage to this tricycle.
- **DO NOT** carry packages or objects on your tricycle in a way that obstructs your view of the road.
- **DO NOT** load this tricycle with more than 330 pounds (150 kg), including 110 pounds (50 kg) in the rear basket.
- **DO NOT** use harsh abrasives or caustic chemicals to maintain this tricycle.
- When inflating the wheel tires, **ALWAYS** maintain 40–65 psi (2.8–4.5 bar).
- For best results, place this tricycle in locations inaccessible to children after use.  
Otherwise, provide constant supervision to prevent accidents.

## 1.6 Electronic Components

- **NEVER** use the throttle, PAS, cruise, or push assist control in any situation, road condition, or terrain where doing so might impair your control of this tricycle.
- **NEVER** use the display panel to adjust the default settings in **Wheel Size**, **Steel Num**, **Boost Magnetic Type**, or **Voltage Level** menu at random or without any professional guidance.
- **NEVER** operate the technician-defined menus in the **Factory Mode** directory randomly on your own.
- **DO NOT** deactivate the display panel by directly turning off the battery, as such an abrupt power cut may damage the components or shorten their lifespans.
- **DO NOT** disassemble the display panel or modify its internal components.
- **DO NOT** disassemble the controller or modify any preconnected wiring.

- **ALWAYS** avoid direct pressurized spray that might allow the interior of the battery, display panel, front light, and other electronic components to become wet.  
If the interior of the battery accidentally becomes wet, replace it with a new identical one. For the other electronic parts, wait for them to completely dry before any further use.
- It is recommended **NOT** to shut off the battery while riding this tricycle, as this may lead to distraction and accidents.
- **DO NOT** focus on the display panel for prolonged periods of time while riding.
- **ALWAYS** turn off the battery between uses.  
For best results, remove the key from the battery to prevent unauthorized use.
- **ALWAYS** remove the battery **FULLY** from this tricycle **BEFORE** performing any cleaning, servicing, and storage.
- **NEVER** place the battery near heat sources or explosive or flammable gases.
- **NEVER** expose the battery to radiation or excessive pressure.
- **ONLY** charge the battery in locations with an ambient temperature between 32° and 113°F (0–45°C).
- **NEVER** disassemble or modify the battery.
- **ONLY** use the provided charger with the battery.
- **NEVER** get the charger wet or operate it with wet hands.
- If the battery is ever damaged, avoid **ALL** contact with it or any leaking fluid. Remove contaminated clothing and flush with copious amounts of water if contact accidentally occurs with the skin.  
If contact accidentally occurs with the eyes, **IMMEDIATELY** flush them with copious amounts of water for at least 15 minutes while seeking medical attention.

# 2. Product Diagram

## 2.1 Overview

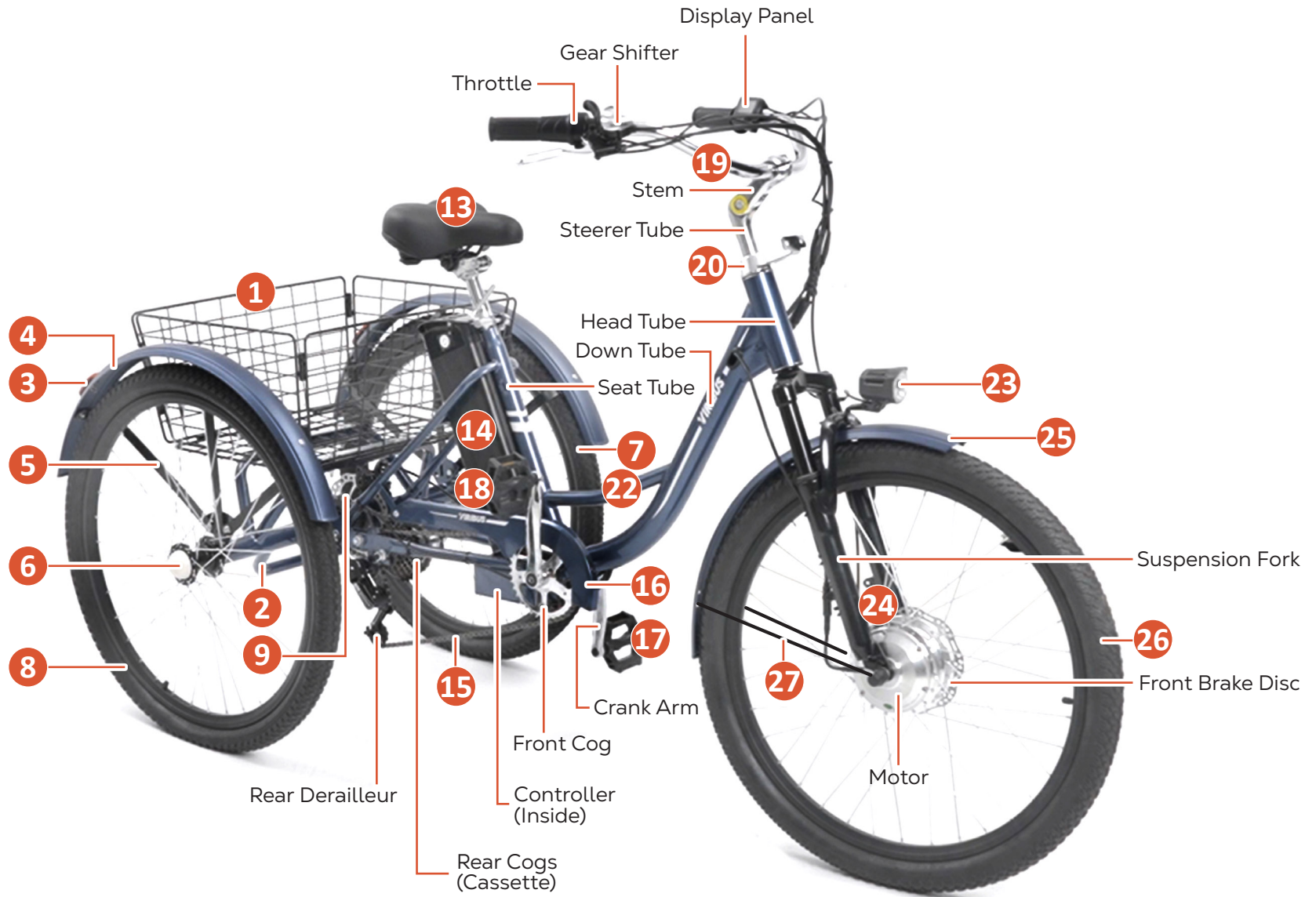



## 2.2 Package Contents

### Important

When you first receive your new tricycle, carefully unpack all these items and check that nothing is missing or has been damaged in transit. If necessary, ask your local dealer or contractor for supplements or replacements.

Besides, storing your original packaging through the warranty period will speed returns if any are needed.

### Main Parts

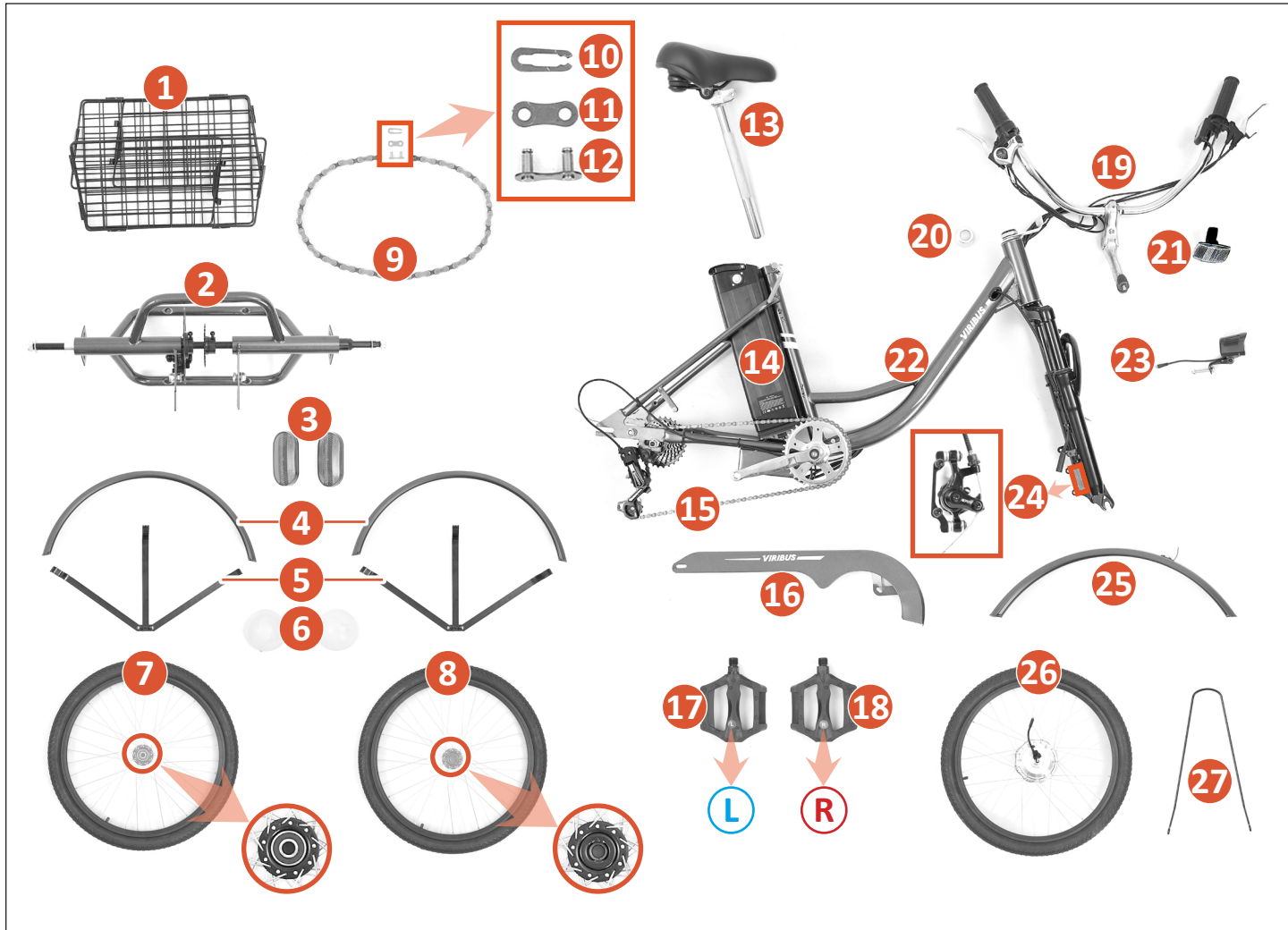

Item	Name	Qty.
1	Rear Basket Frame	1
2	Rear Frame	1
3	Rear Reflectors	2
4	Rear Fenders	2
5	Rear Fender Stays	2
6	Rear Wheel Caps	2
7	Rear Left Wheel	1
8	Rear Right Wheel	1
9	Short Chain	1
10	Clip	1
11	Locking Plate	1
12	Link	1
13	Saddle	1
14	Battery	1
15	Long Chain	1
16	Chain Guard	1
17	Left Pedal (L)	1
18	Right Pedal (R)	1
19	Handlebars	1
20	Collar	1
21	Front Reflector	1
22	Main Frame	1
23	Front Light	1
24	Front Brake Caliper	1
25	Front Fender	1
26	Motorized Front Wheel	1
27	Front Fender Stay	1



## Fasteners

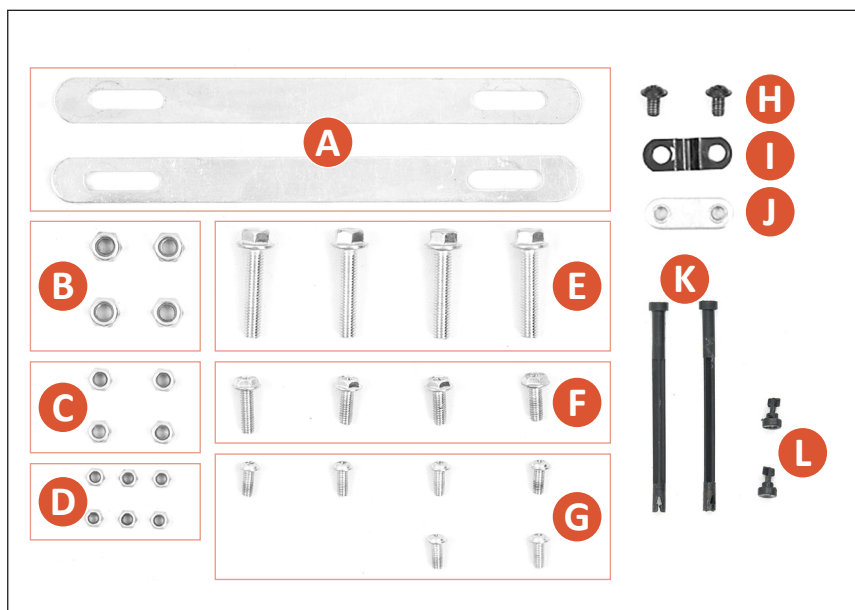

Item	Name	Usage	Qty.
A	Slats	Rear Basket	2
B	M8 Nuts		4
C	M6 Nuts	Rear Fender Stays	4
D	M5 Nuts	Rear Fenders & Stays	6
E	M8×40 Hex-Head Bolts	Rear Basket	4
F	M6×16 Phillips Bolts	Rear Fender Stays	4
G	M5×10 Phillips Bolts	Rear Fenders & Stays	6
H	M6×8 Phillips Bolts	Front Fender & Stay	2
I	Upper Connecting Plate		1
J	Lower Connecting Plate		1
K	Locking Pins	Rear Basket	2
L	Tabs		2

## Tools

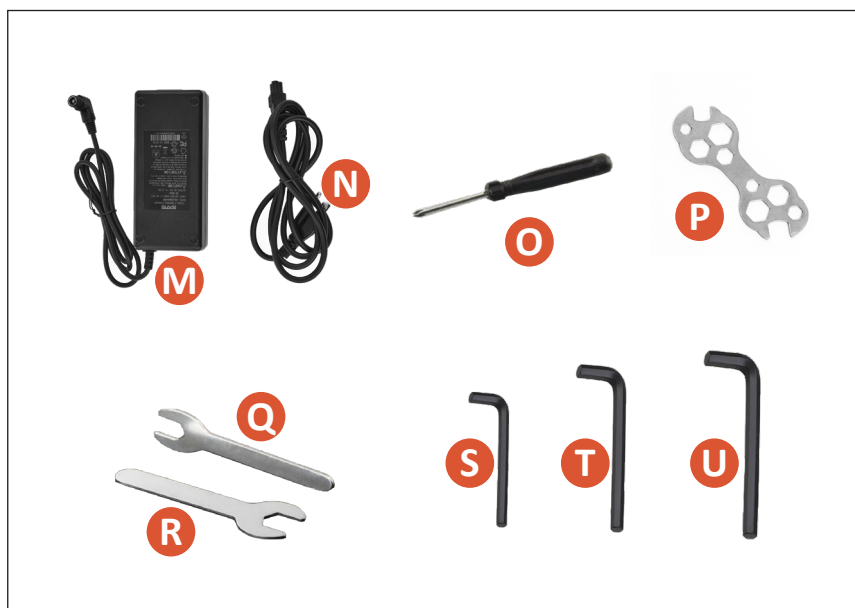

Item	Name	Qty.
M	Charger	1
N	Power Cord	1
O	Dual-Purpose Screwdriver	1
P	Multifunctional Wrench	1
Q	18 mm Wrench	1
R	22 mm Wrench	1
S	M4 Hex Wrench	1
T	M5 Hex Wrench	1
U	M6 Hex Wrench	1

## Not Included but Helpful

Work Gloves



Goggles





## 2.3 Handlebars

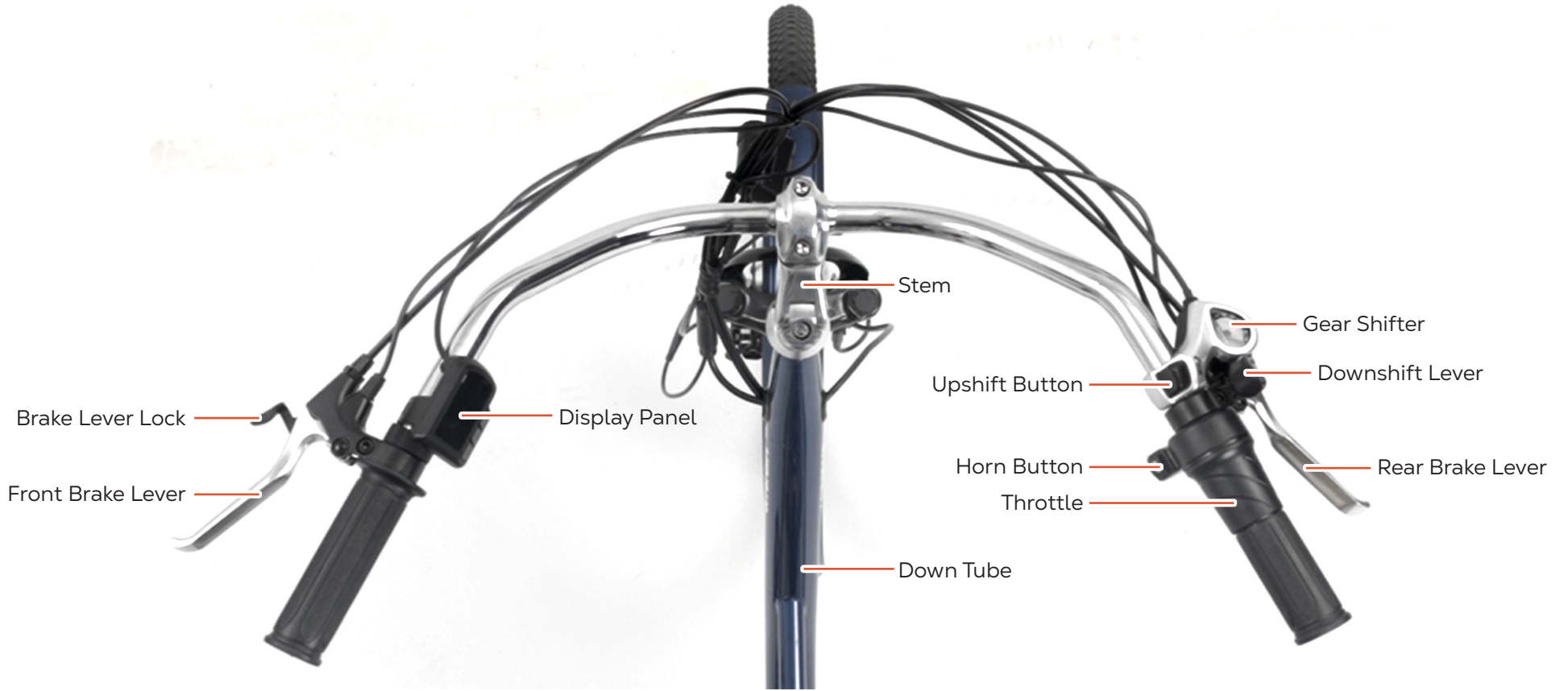

## 2.4 Display Panel

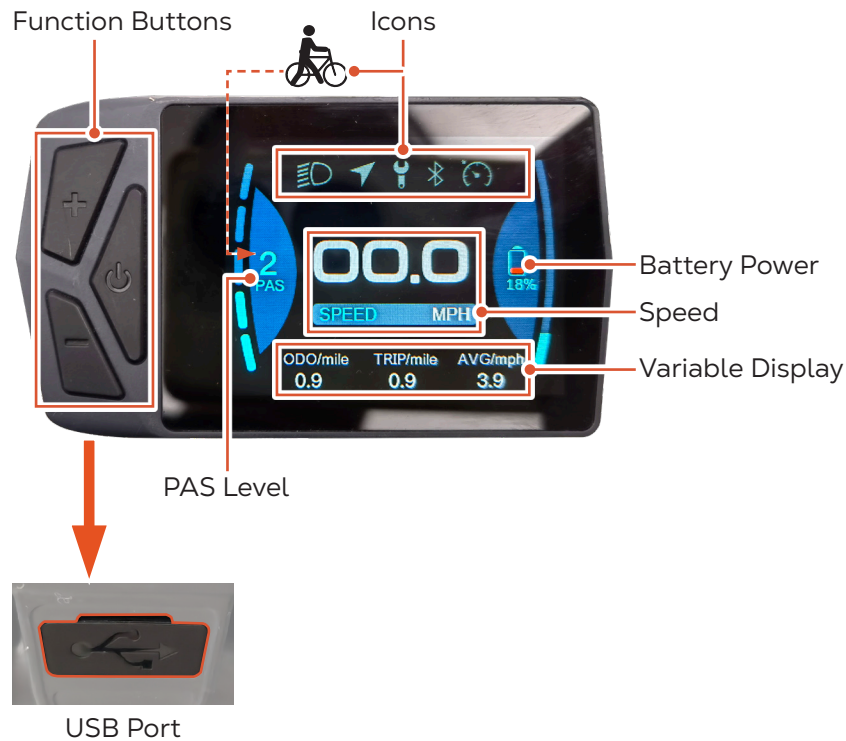

Function Buttons	⏻	Confirms settings adjustment when pressed. Turns on/off the display panel when held.
	+	Increases the pedal assist level when pressed. Turns on/off the front light when held.
	-	Decreases the pedal assist level when pressed. Activates cruise or push assist control when held.
Display Areas	Battery Power	Shows the remaining battery power level (0 to 100%).
	PAS Level	Shows the current pedal assist level (0 to 5).
	Speed	Shows the current speed in mph or km/h.
	Variable Display	Shows your total distance traveled (ODO), current trip distance (TRIP), and average speed of the current trip (AVG).
Icons	☹️	Indicates the front light is on.
	📍	Indicates navigation is operating.
	⚠️	Indicates system errors.
	📶	Indicates Bluetooth is operating.
	🕒	Indicates cruise control is operating.
	🚲	Indicates push assist control is operating.
USB Port		Charges mobile devices through a type C cable (not included).



### 3. Specifications

Motor Power		350 W	
Display Panel	Screen Type	Liquid Crystal Display (LCD)	
	USB Port	Type C	
	Weatherproof Rating	IPX6	
Front Light Weatherproof Rating		IPX5	
Battery	Type	48 V Lithium	
	Weatherproof Rating	IPX6	
	Operational Temp.	-4 to 140°F	-20 to 60°C
	Charging Temp.	32 to 113°F	0 to 45°C
	Optimal Storage Temp.	50 to 77°F	10 to 25°C
Weight Capacity	Rear Basket	110 lb.	50 kg
	Total	330 lb.	150 kg
Rider Height Range		5.3 to 5.9 ft.	160 to 180 cm
Max. Speed		15.5 mph <sup>(1)</sup>	25 km/h <sup>(1)</sup>
Max. Travel		38.5 mi. <sup>(2)</sup>	62 km <sup>(2)</sup>
Tires	Pressure Range	40 to 65 psi	2.8 to 4.5 bar
	Type	24×2.125 or 26×2.125 in.	

(1) Based on unloaded wheel rotation at full power without friction

True maximum speed will vary according to variables such as battery strength and load but should remain ±1 mph of the preset value.

(2) Based on a 165 lb. or 75 kg load at full power and full legal speed on actual roads

### 4. Assembly

#### Warning

To ensure optimal safety, be sure to fulfill the following conditions during assembly.

- Keep your work area clean and well-lit. Cluttered or dark areas invite accidents.
- Wear hand and eye protection to prevent accidents. Work gloves and goggles (not included) are strongly recommended. If necessary, ask one or more persons for assistance **BUT** remember to have everyone wear equivalent personal protective equipment.
- **DO NOT** allow children or pets to play with **ANY** tricycle parts, tools, or packaging materials. Provide constant supervision or restrict access to your work area as needed.
- **DO NOT** leave the key in the **ON** position on the battery during assembly. For best results, remove the battery from the main frame before starting your work.

#### Important

To see these instructions in video form, go to our **YouTube** channel **Viribus Workshop** and search for “**ABE-S**”.

## 4.1 Installing the Rear Wheels

### Read This First

- The two rear wheels **ARE** different and **NOT** interchangeable.
- Remove the protective covers and 2 sets of washers and nuts from the rear frame axle in advance. Place these washers and nuts nearby.

### 4.1.1 Installing the Rear Right Wheel

1



Identify:

- Rear wheel with the D-shaped slot (8)
- D-shaped hub without spacers on the rear frame (2)

3



Push the wheel slot onto the hub.

4

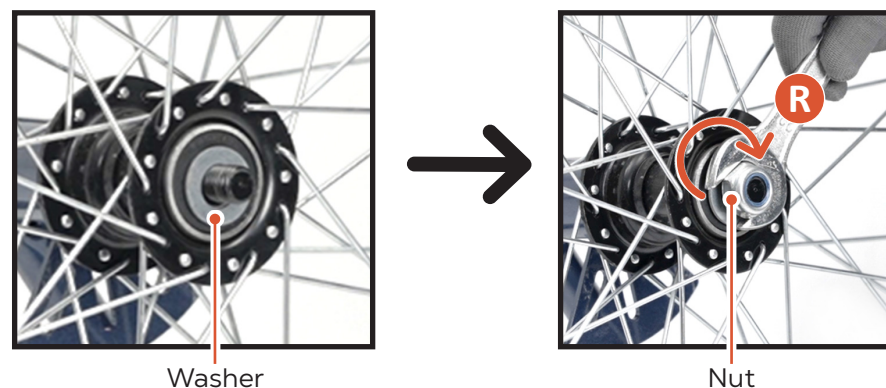

- Replace a set of washer and nut.
- Tighten the nut using the 22 mm wrench (R).

## 4.1.2 Installing the Rear Left Wheel



Spacer

Identify:

- Rear wheel with the O-shaped slot (7)
- O-shaped hub with a spacer on the rear frame (2)



Push the wheel slot onto the hub.

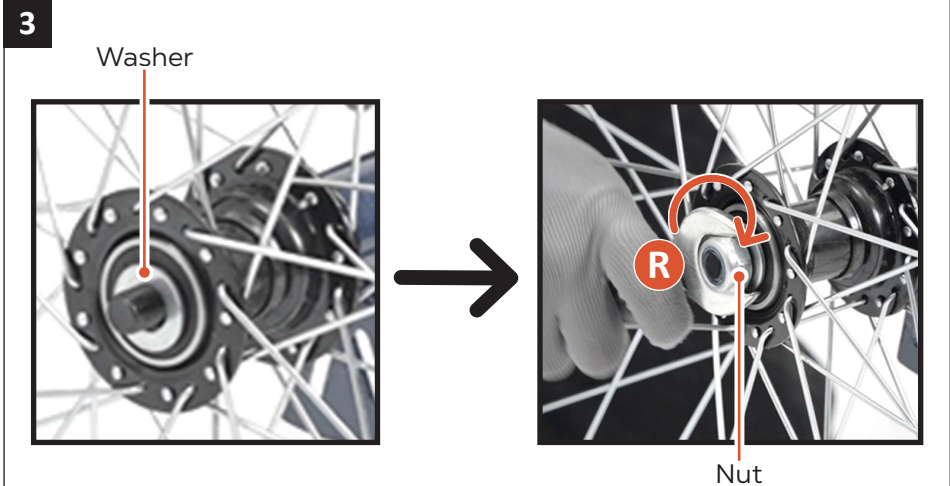

- Replace the remaining set of washer and nut.
- Tighten the nut using the 22 mm wrench (R).

## 4.2 Installing the Handlebars

### Read This First

- Exercise caution with the steerer tube to prevent personal injury.
- Remove the protective cover from the bottom of the steerer tube in advance.

1

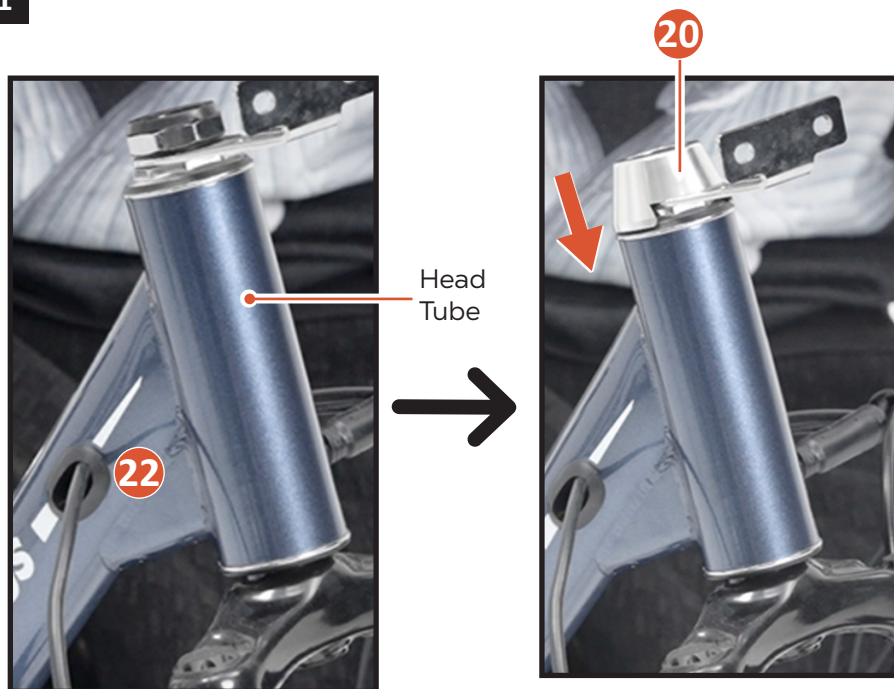

Fit the collar **(20)** to the hole at the top of the head tube on the main frame **(22)**.

Ensure that the collar is correctly seated as shown.

2

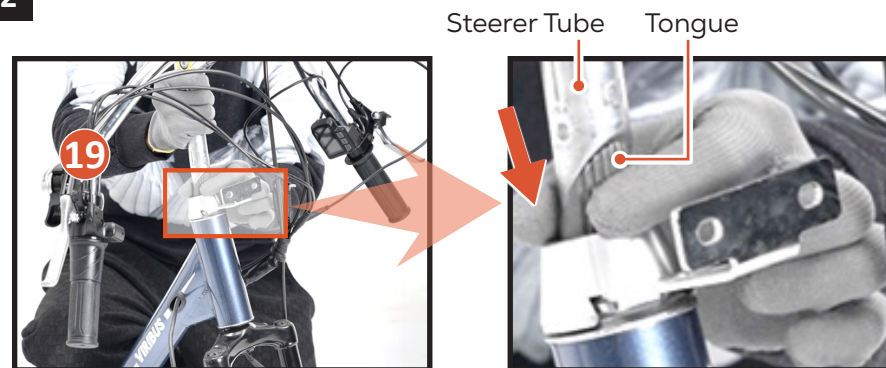

- Ensure the tongue remains loose and correctly positioned.
- Insert the steerer tube of the handlebars **(19)** into the head tube until your preferred height is reached.

3

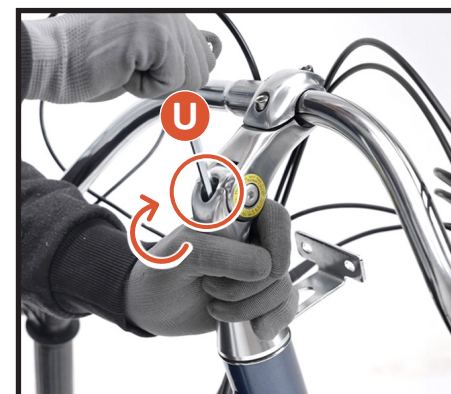

Tighten the bolt at the top of the steerer tube using the M6 hex wrench **(U)**.

4

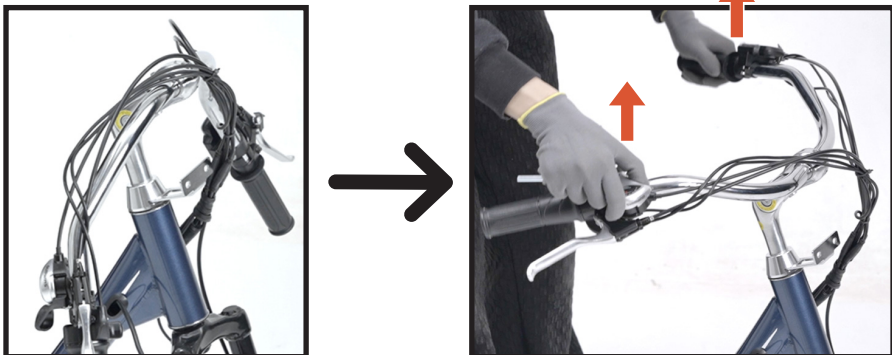

Lift the handlebars as shown.

5

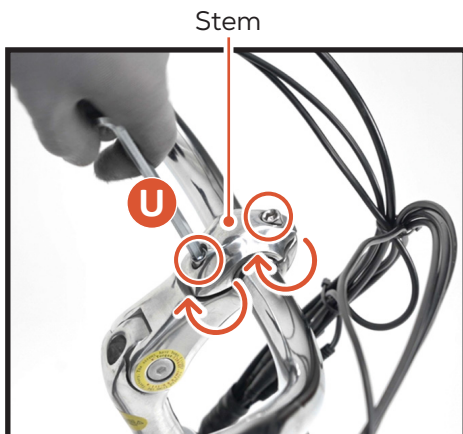

Tighten the two bolts on the stem using the M6 hex wrench (U).

### 4.3 Installing the Saddle

1



Insert the post of the saddle (13) into the seat tube until your preferred height is reached.

2



Rotate the locking handle clockwise until the saddle is locked into place.



## 4.4 Connecting the Main and Rear Frames

### Read This First

- If necessary, remove the battery (14) from the main frame following **Charging** on Page 33.
- Ensure that the 4 sets of bolts and nuts mentioned here are loose in advance.

1

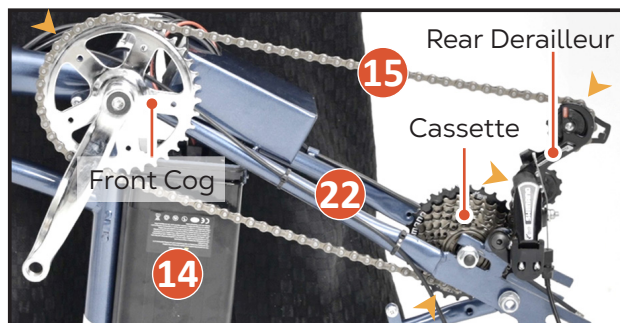
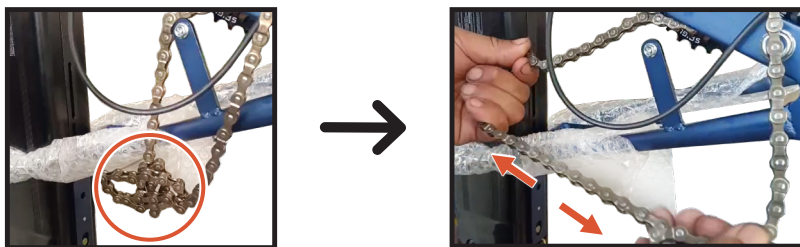

- Turn the main frame (22) upside down.
- Remove the protective bubble wrap from the long chain (15) and snip the zip tie on the rear derailleur.
- Straighten the front part of the long chain and prevent it from wrapping around the main frame.

**Note:** This long chain does not have a main chain buckle and cannot be separated into 2 sections. If the long chain is wrapped around the main frame, carefully untangle it.

- Place the long chain around the front cog, a rear cog on the cassette, and the pulleys on the rear derailleur.

2

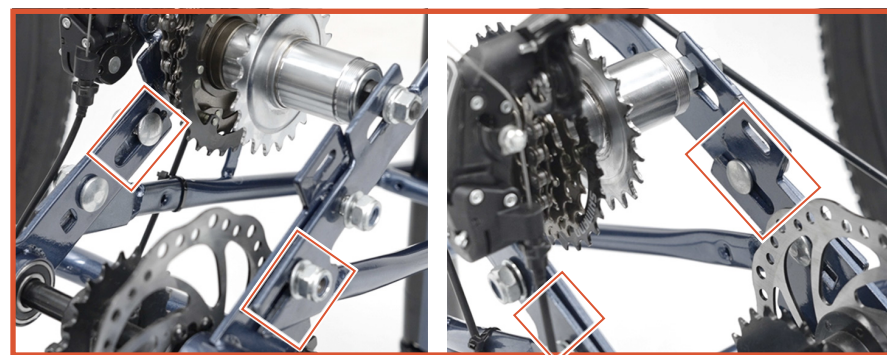
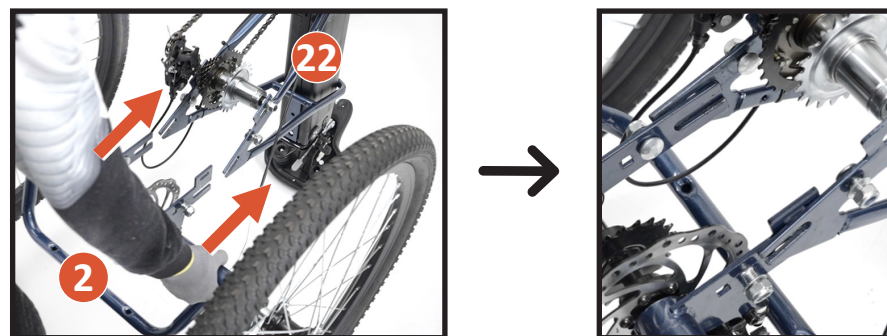

- Ensure the bolts and slots are well aligned as shown.
- Push the rear frame (2) to the main frame.
- Partially tighten the bolts and nuts by hand.  
(Tighten them completely after short chain installation.)

## 4.5 Installing the Short Chain

1

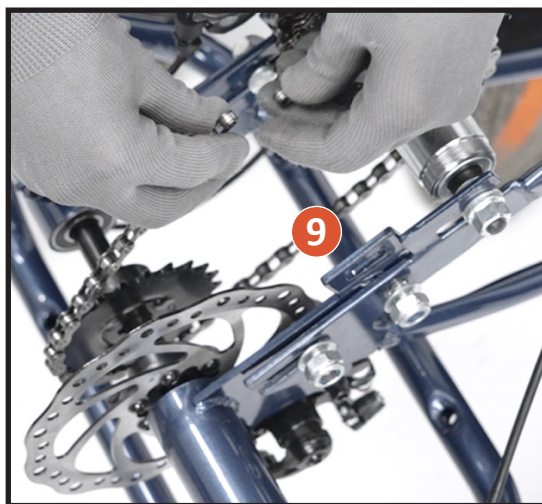
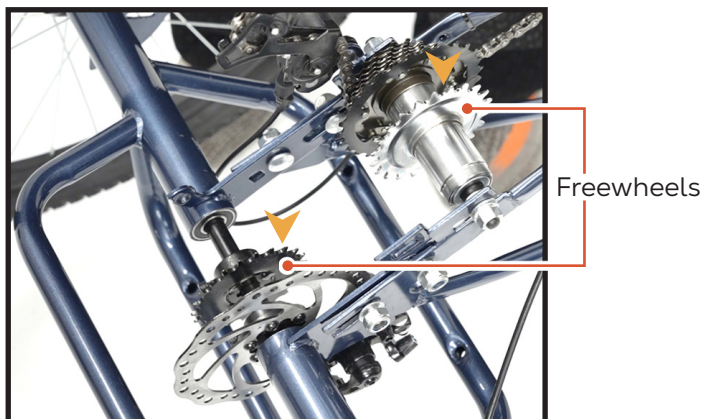

Place the short chain **(9)** around the two freewheels.

2

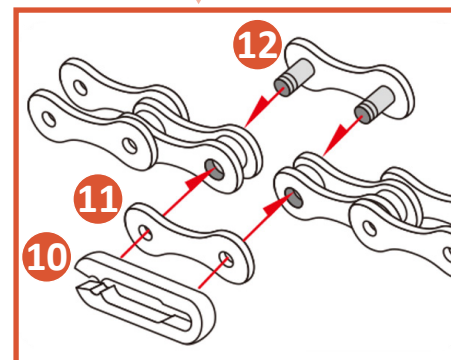
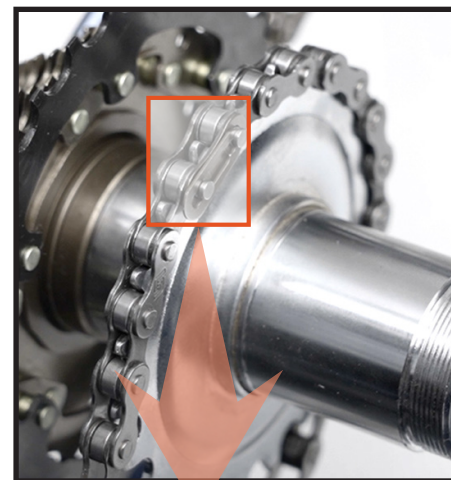

- a. Use the link **(12)** and locking plate **(11)** to join the ends, pressing the link pins into the slots.
- b. Push the clip **(10)** onto the link pins to lock the ends.

3

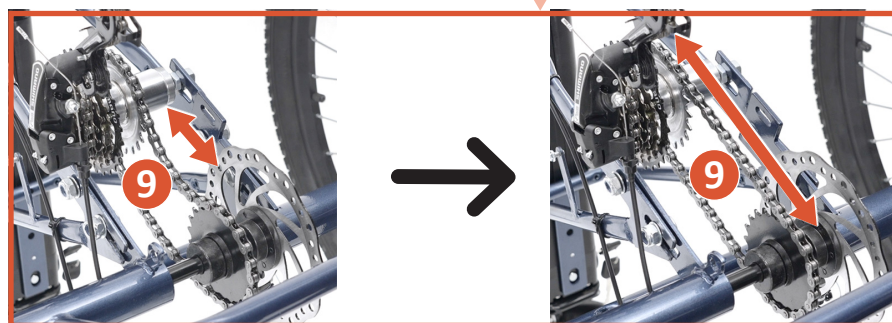
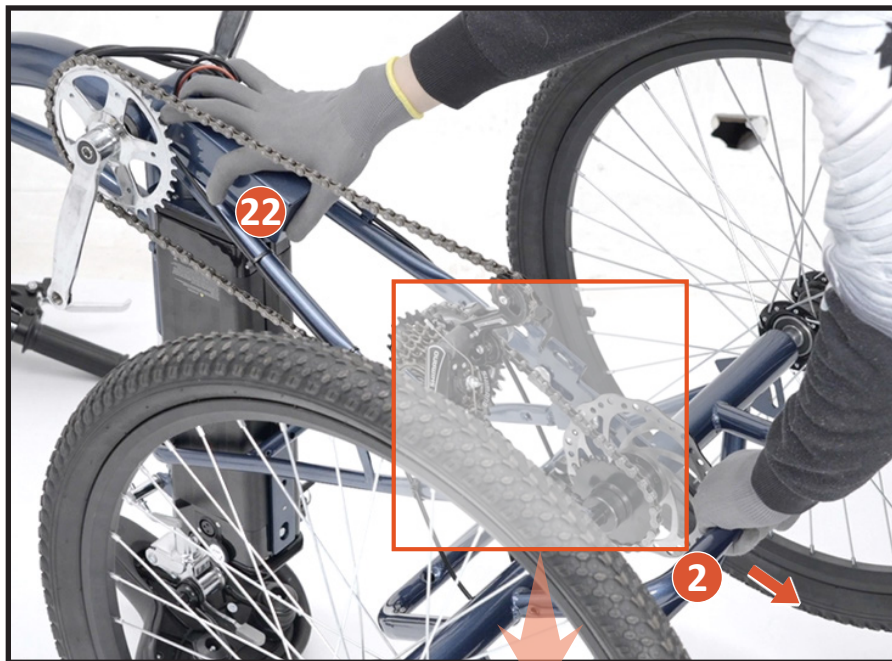

Firmly hold the main frame (22), pulling the rear frame (2) backward until the short chain (9) is taut.

4

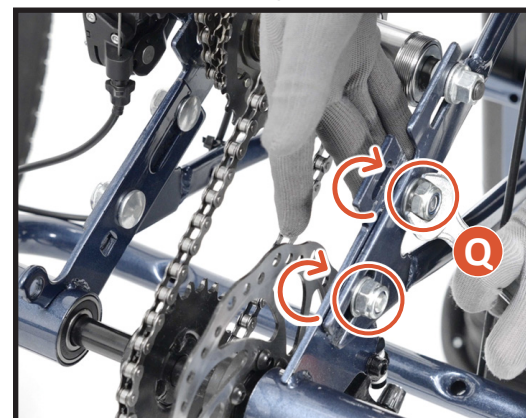
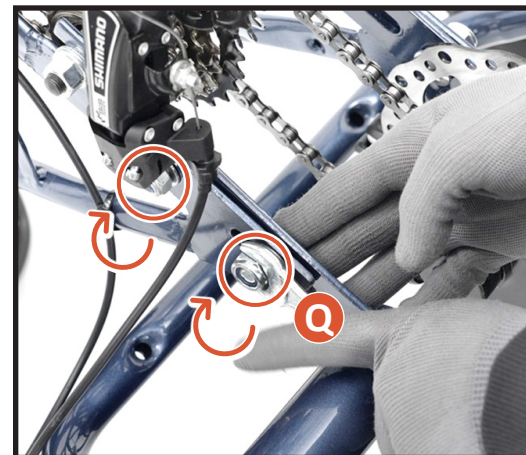

Tighten the 4 sets of nuts using the 18 mm wrench (Q) to secure the frame connections.

## 4.6 Installing the Front Fender, Stay, Brake Caliper, and Light

### 4.6.1 Connecting the Front Fender Stay to the Front Fender

1

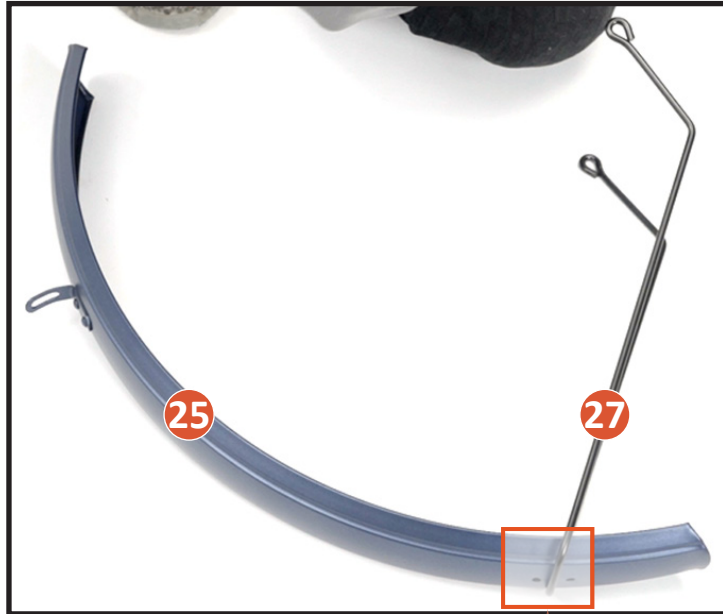

Place the front fender stay (27) between the two holes on the front fender (25).

2

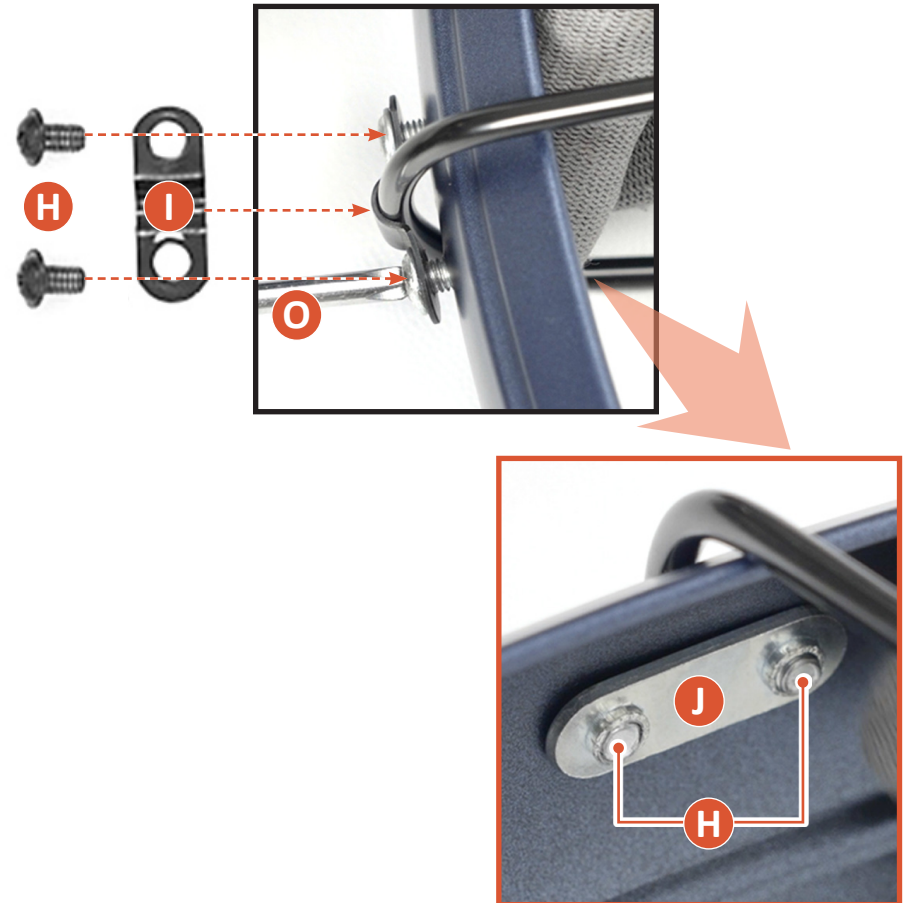

- Use the two connecting plates (I & J) and M6×8 Phillips bolts (H) to connect the stay to the fender.
- Tighten these bolts using the dual-purpose screwdriver (O).

## 4.6.2 Installing the Front Brake Caliper

**1**



Caliper Holder

24

a. Remove the two bolts from the front brake caliper (24).  
b. Align the caliper with its holder on the suspension fork.

Detailed description: This step is divided into two sub-images. The top image shows two suspension forks with a bracket labeled 'Caliper Holder' attached to them. Two bolts are indicated by red lines. The bottom image shows a hand using a hex key to remove one of the bolts from the caliper, which is marked with a red circle containing the number '24'. An arrow points from the top image to the bottom image.

**2**

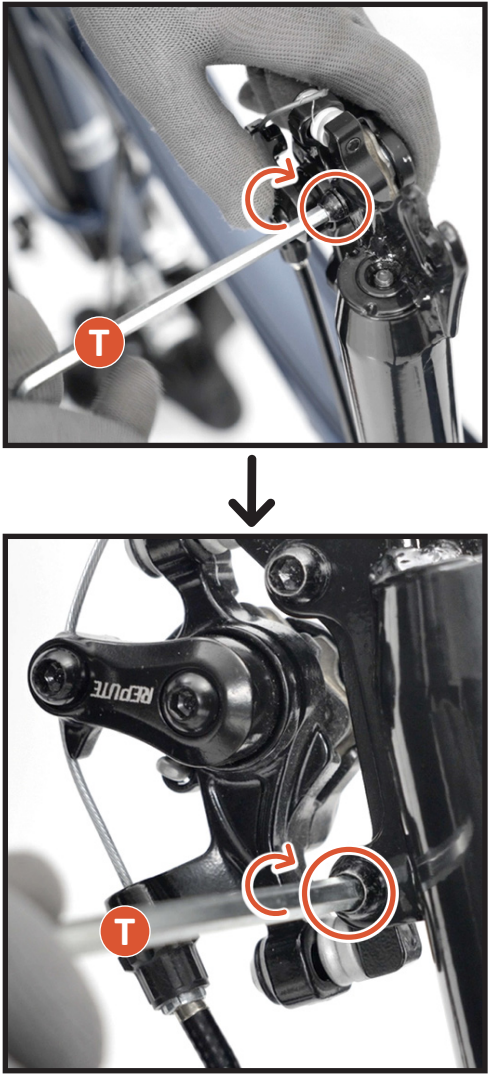

T

T

Use the M5 hex wrench (T) to secure the caliper with the removed bolts.

Detailed description: This step is divided into two sub-images. The top image shows a hand using an M5 hex wrench, marked with a red circle and 'T', to tighten one of the bolts on the caliper. A red arrow indicates the clockwise direction of rotation. The bottom image shows the same process for the second bolt. An arrow points from the top image to the bottom image.

### 4.6.3 Connecting the Rear Fender Stay to the Suspension Fork

1

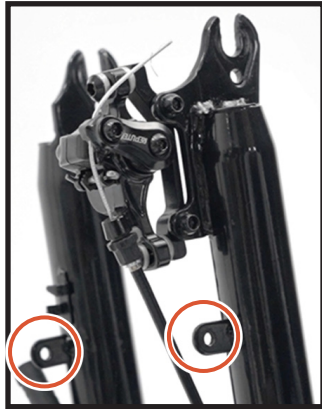

Remove the short bolts from the side slots on the suspension fork.

2



- Remove the nut and long bolt from the fork's front rack.
- Place the front fender (25) into the fork as shown.

3

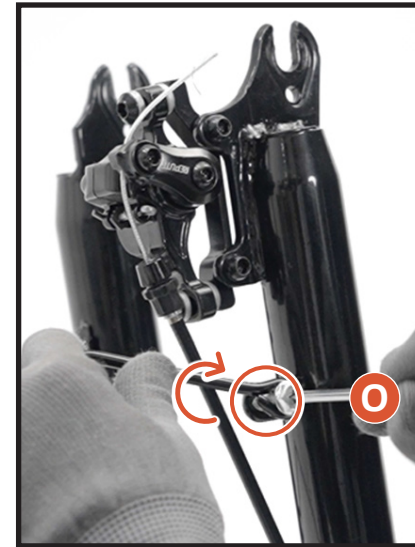
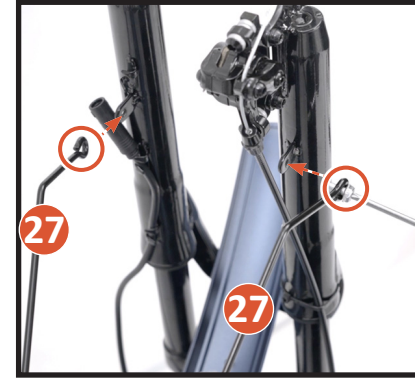

- Align the front fender stay (27) with the side slots.
- Use the dual-purpose screwdriver (O) to secure the stay to the fork with the removed short bolts.

#### 4.6.4 Installing the Front Light

1



Locate this bolt hole on the suspension fork's front rack.

2



- a. Position the front light (23) against the front rack.
- b. Align its holder with the bolt hole and the top slot of the front fender (25).

3

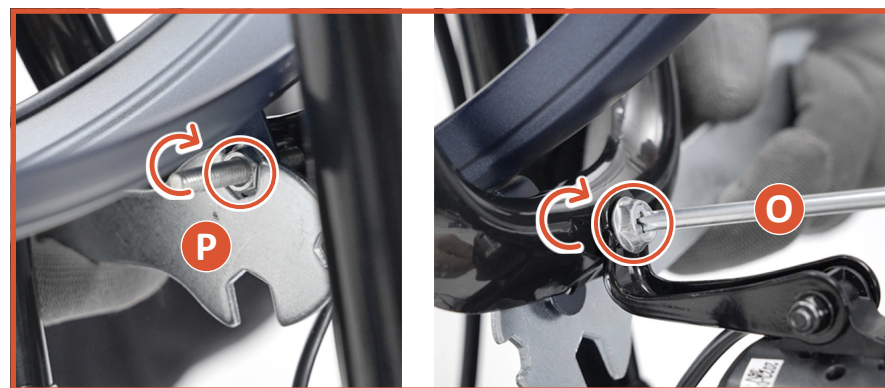
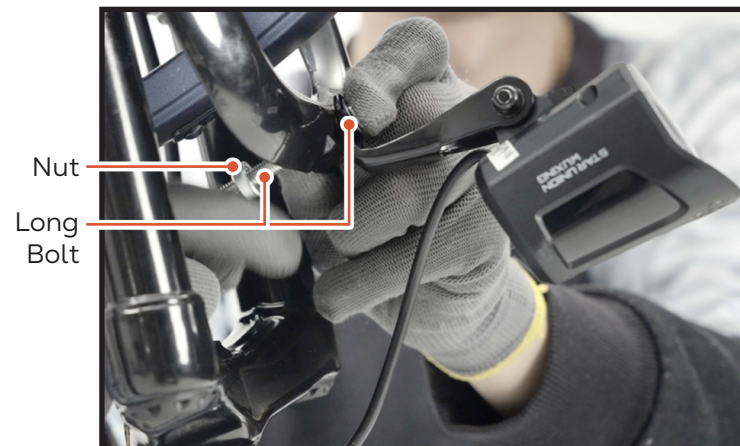

- a. Replace the long bolt and nut mentioned in 4.6.3 on Page 19.
- b. Tighten them using the dual-purpose screwdriver (O) and multifunctional wrench (P).

## 4.7 Installing the Motorized Front Wheel

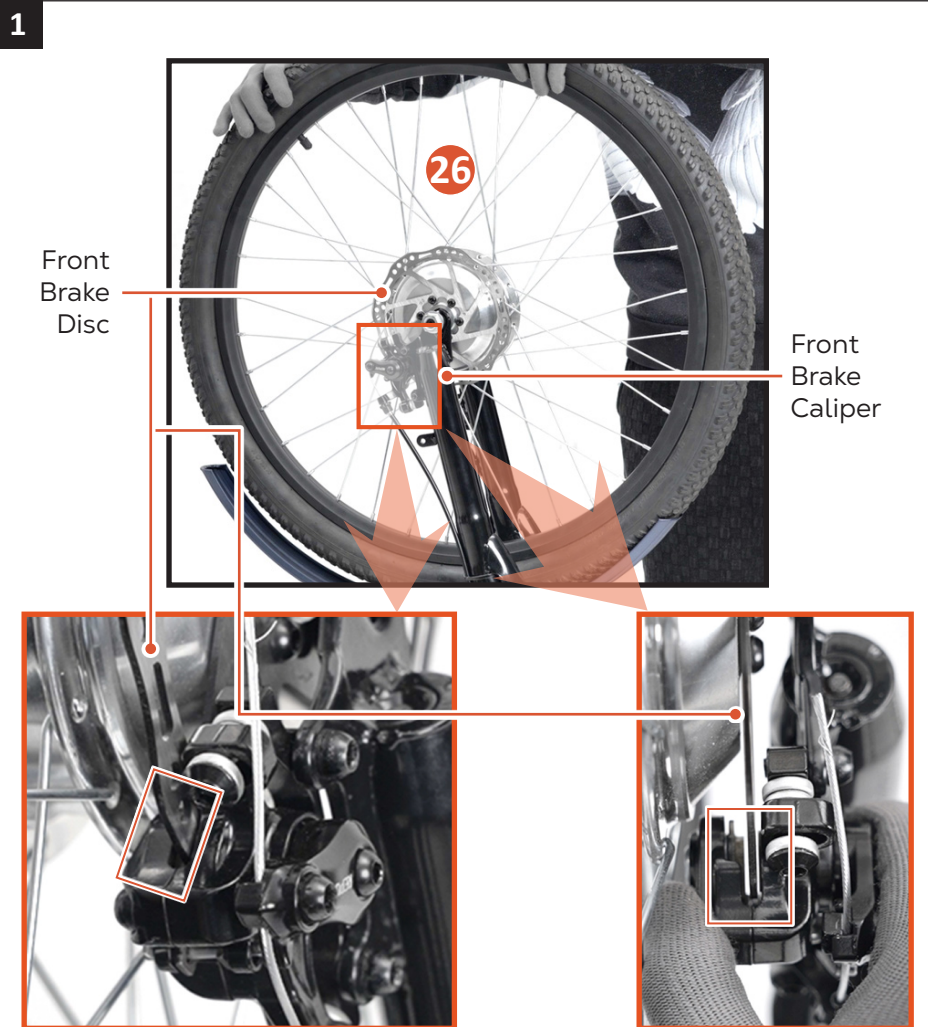

Fit the motorized front wheel (**26**) onto the suspension fork.

Ensure:

- The wheel axle is snugly held by the fork tips.
- The front brake disc is well fitted into the front brake caliper.

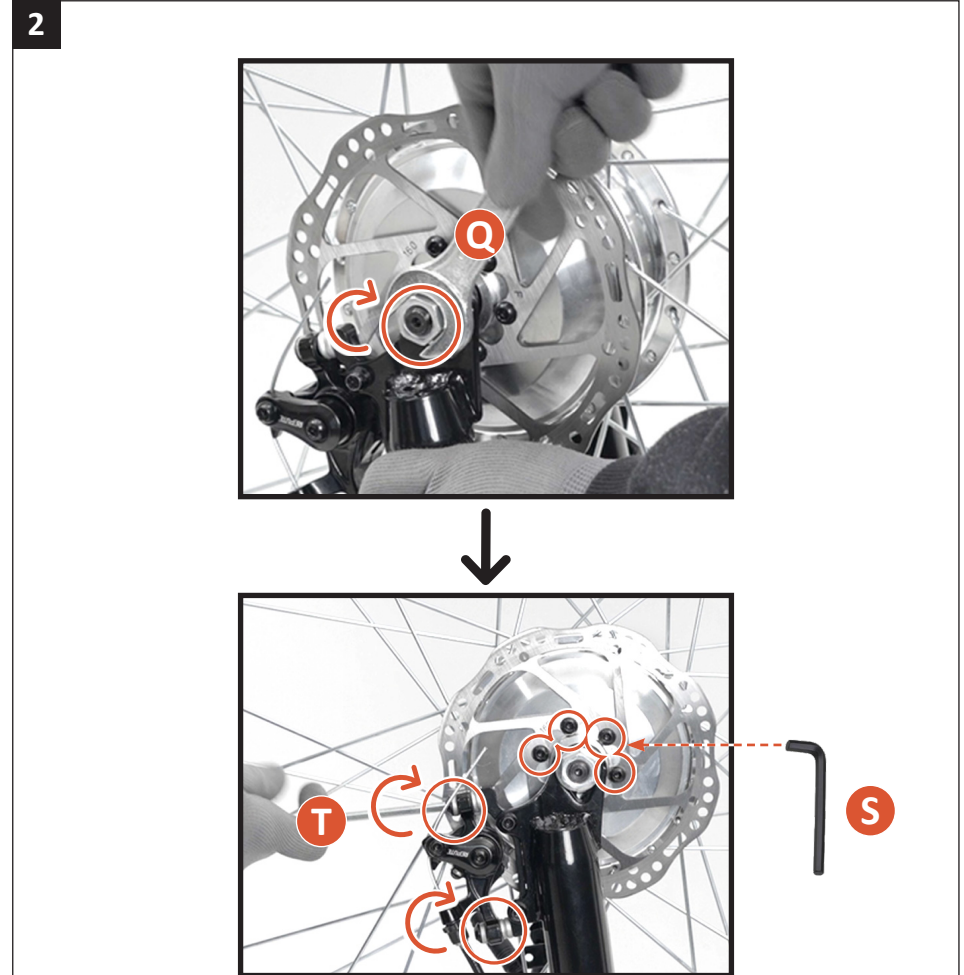

- Tighten the nuts on the wheel axle using the 18 mm wrench (**Q**).
- Tighten the nuts on the caliper using the M5 hex wrench (**T**).
- If the brake disc comes loose, tighten its locking bolts using the M4 hex wrench (**S**).



## 4.8 Installing the Rear Reflectors

1

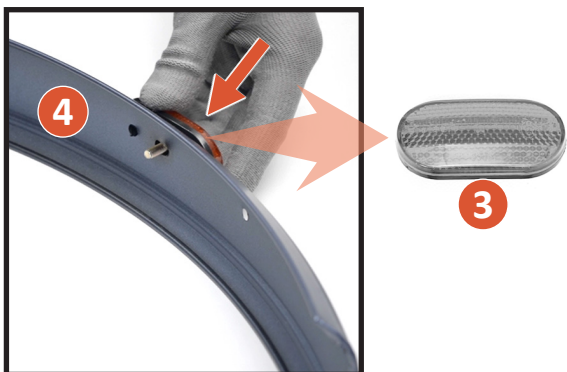

- a. Remove the nuts from the bolts on the rear reflectors (3).
- b. Attach the reflectors to the rear fenders (4) using their bolts.

2



Use the multifunctional wrench (P) to secure the reflectors with the removed nuts.

## 4.9 Installing the Rear Fenders and Stays

### Read This First

Turn the tricycle frame right side up slowly and carefully in advance.

### 4.9.1 Connecting the Rear Fender Stays to the Rear Fenders

1

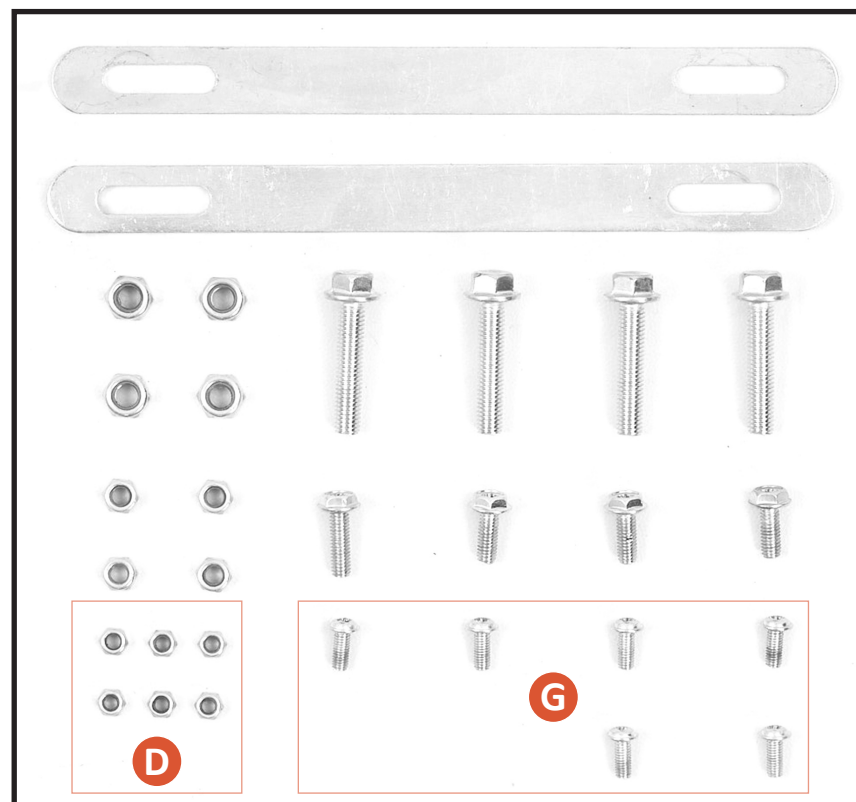

Select the 6 sets of M5×10 Phillips bolts (G) and M5 nuts (D).

2

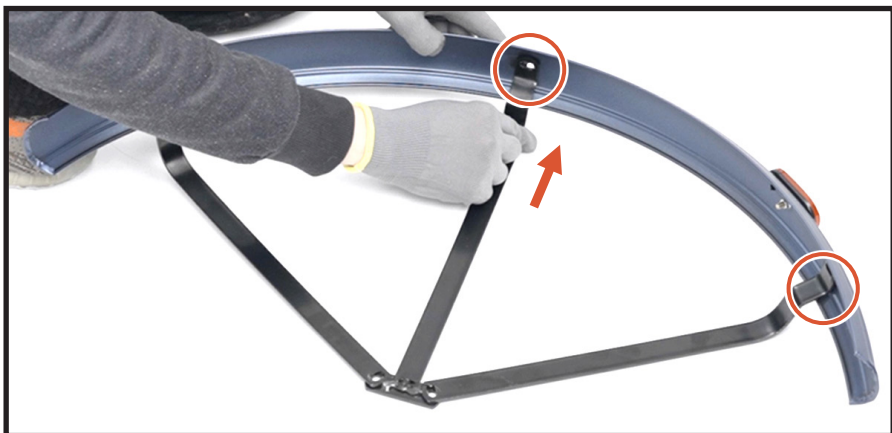
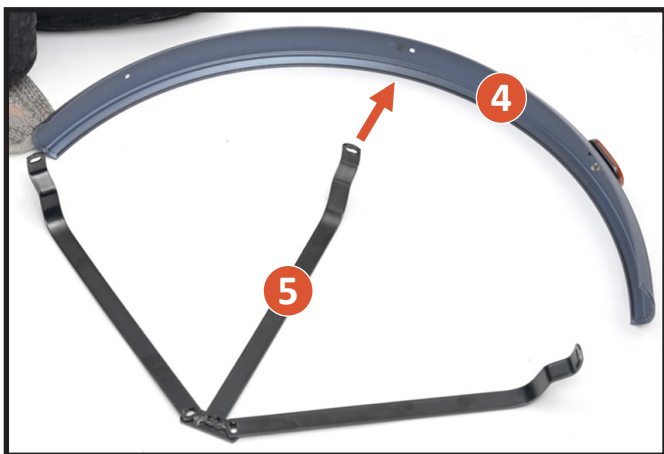

Place the rear fender stays (5) against the rear fenders (4). Ensure their holes are well aligned.

3

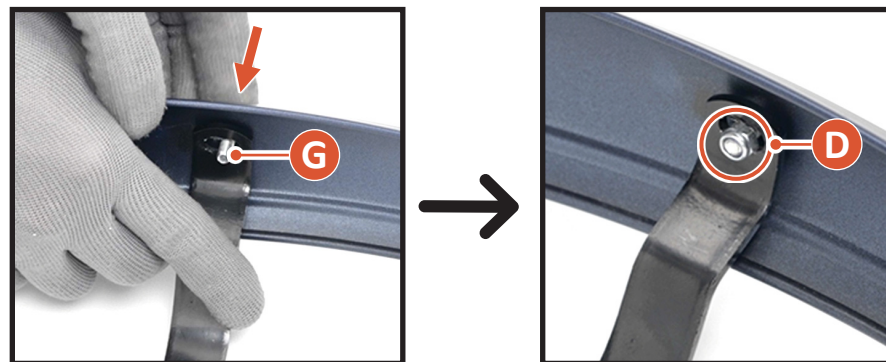

Use the selected bolts (G) and nuts (D) to connect the stays to the fenders.

4



Tighten the bolts and nuts using the dual-purpose screwdriver (O) and multifunctional wrench (P).

#### 4.9.2 Connecting the Rear Fender Stays to the Rear Frame

1

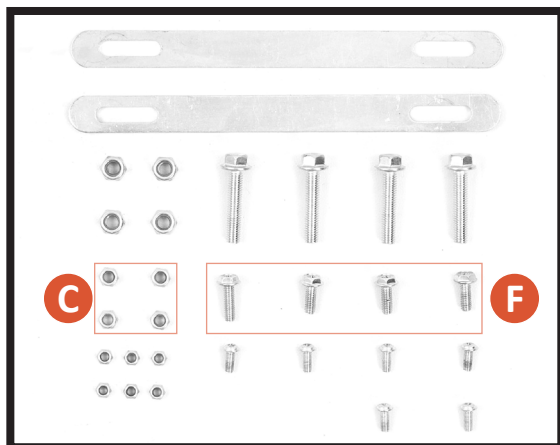

Select the 4 sets of M6x16 Phillips bolts (F) and M6 nuts (C).

2



Place the appropriate rear fender (4) above the rear right wheel (8).

Ensure:

- The rear reflector (3) is facing backwards.
- The rear fender stay (5) is positioned at the wheel's **INNER** side.

3

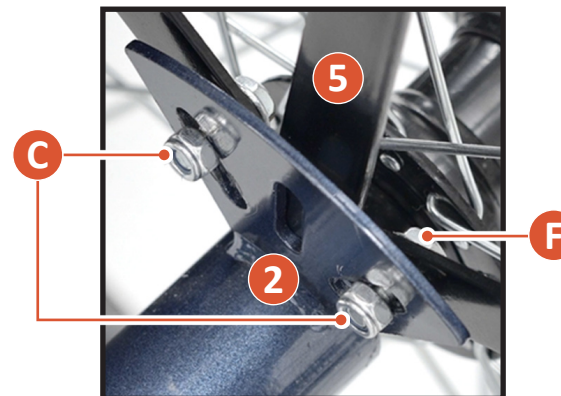

Use 2 sets of the selected bolts and nuts to connect the fender stay to the fan-shaped bracket on the rear frame (2).

4



Tighten the bolts and nuts using the dual-purpose screwdriver (O) and multifunctional wrench (P).

5

Repeat these steps for the other rear fender stay over the rear left wheel.

## 4.10 Feeding the Rear Brake Cable

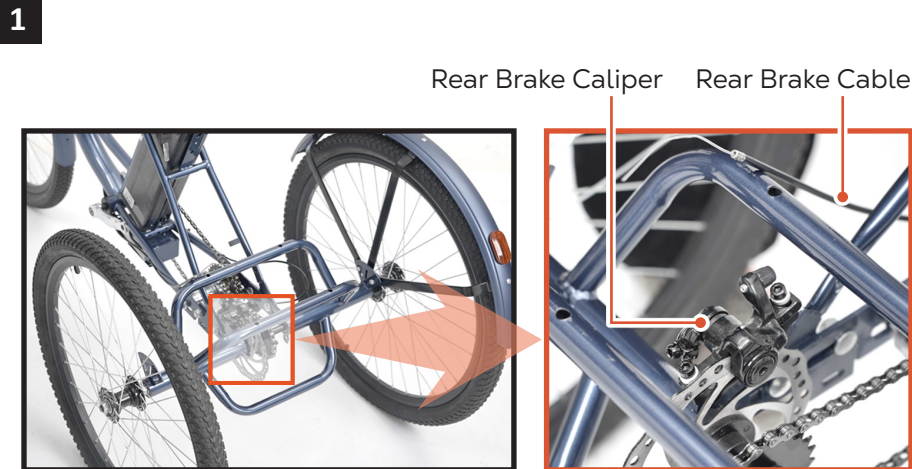

Locate the rear brake caliper and cable as shown.

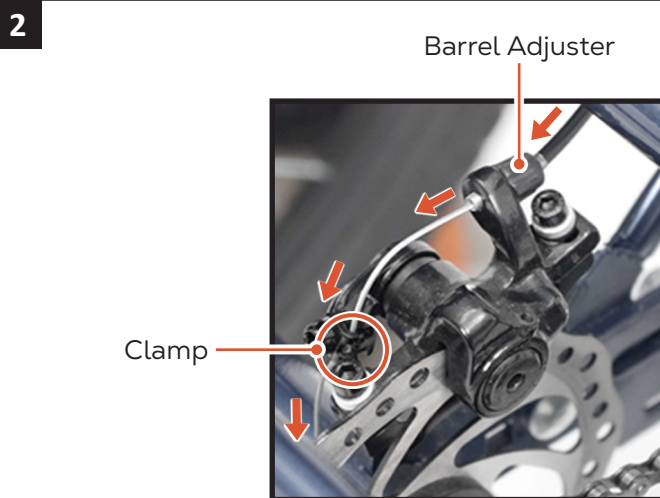

Feed the cable through the barrel adjuster and clamp on the caliper.

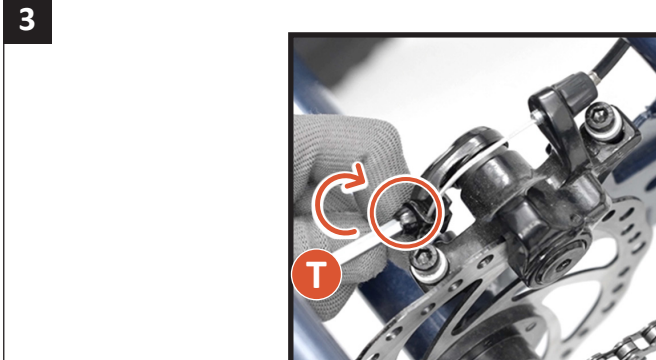

Use the M5 hex wrench (T) to tighten the clamp bolt, securing the cable to the caliper.

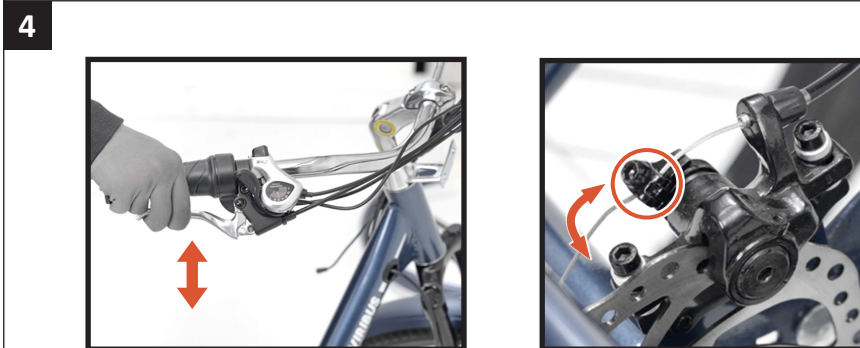

- a. Press the rear brake lever on the right handlebar to test the caliper's smooth and effective operation.  
If necessary, fine-tune the barrel adjuster until you feel comfortable with the cable tension **BUT** be sure that the rear brake system remains effective.
- b. Use the front brake lever on the left handlebar to test the front brake system, adjusting its cable tension as needed in the same fashion.

## 4.11 Installing the Rear Basket

### 4.11.1 Assembling the Basket Frame

1

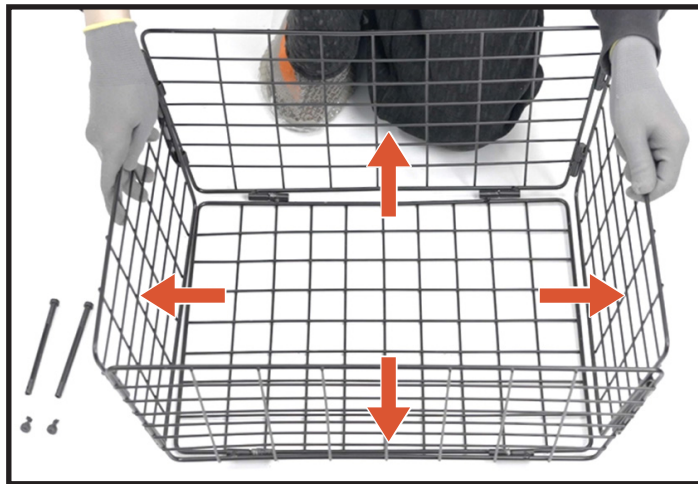

Unfold the rear basket frame (1) as shown.

2

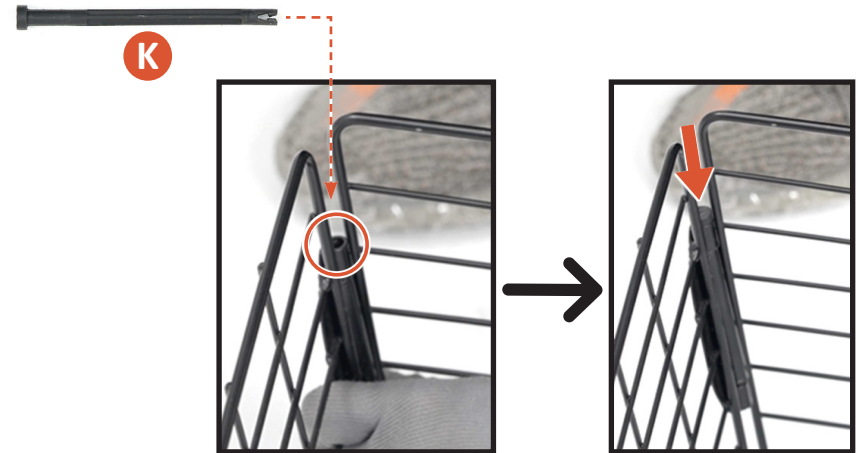

Insert the locking pins (K) into the slots to join the sides.

3

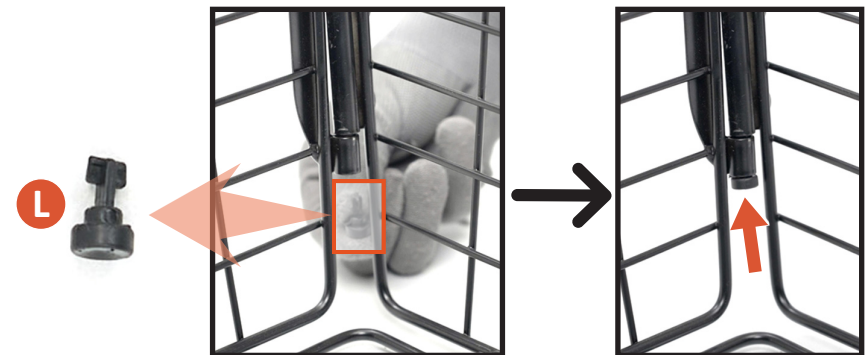

Push the tabs (L) onto the bottom of the pins to secure the joints.

### 4.11.2 Mounting the Basket Frame

1

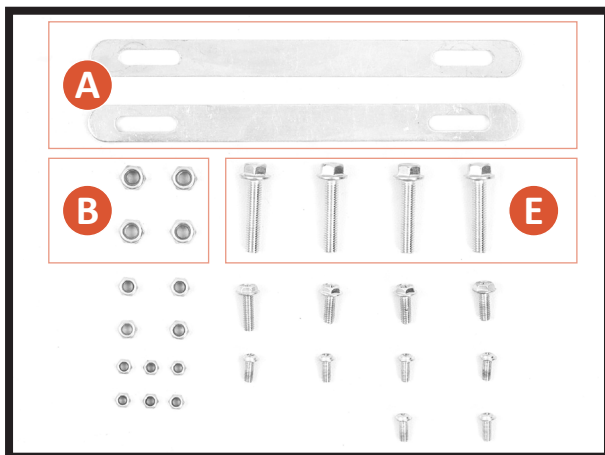

Select the slats **(A)**, M8×40 hex-head bolts **(E)** and M8 nuts **(B)**.

2



Fit the basket frame **(1)** onto the rear frame **(2)**.

3

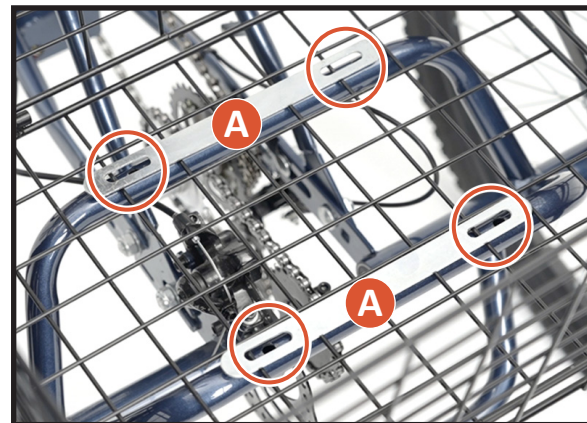

Place the slat **(A)** onto the basket, aligning its slots with the rear frame's holes.

4

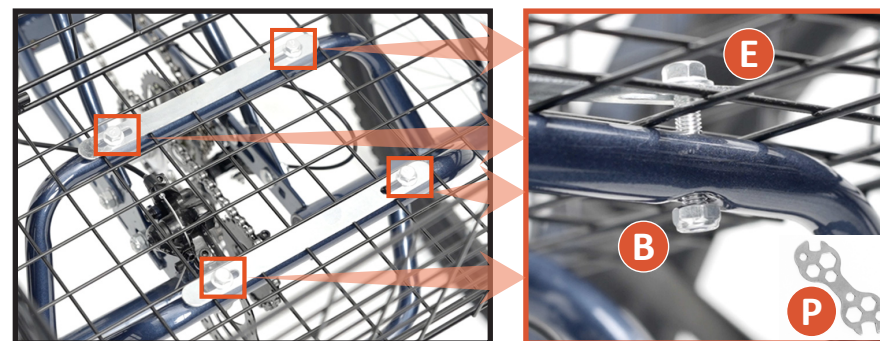

Use the selected bolts and nuts to secure the basket to the frame.

Tighten them with the multifunctional wrench **(P)** or your 10 mm wrench.

## 4.12 Installing the Chain Guard

1



Use the dual-purpose screwdriver (O) to remove the two bolts from the supports beside the front and rear cogs.

2



Place the chain guard (16) over the front cog and long chain (15) as shown.

3



Use a removed bolt to secure the guard to its front support.

4



Use the other removed bolt to secure the guard to its rear support.

### 4.13 Installing the Pedals

**Note:** Identify the separate pedals, which **ARE** different and should **NOT** be mixed up. The left pedal (17) is marked with **L** and the right (18) with **R**. The threads on the two pedals are opposite, twisting in the wrong direction may damage the pedal threads.

1

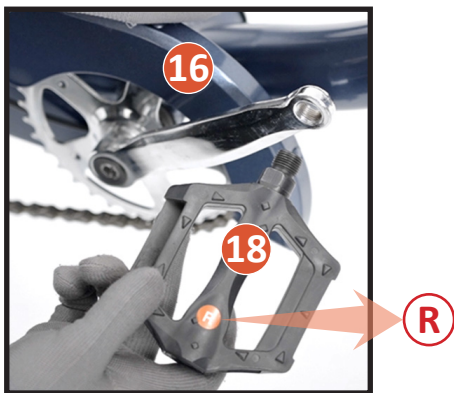

Screw the pedal labeled **R** (18) onto the crank arm near the chain guard (16) at the **RIGHT** side.

2



Tighten the locking nut to secure the pedal into place.  
Use the multifunctional wrench (**P**) or your 15 mm wrench.

3

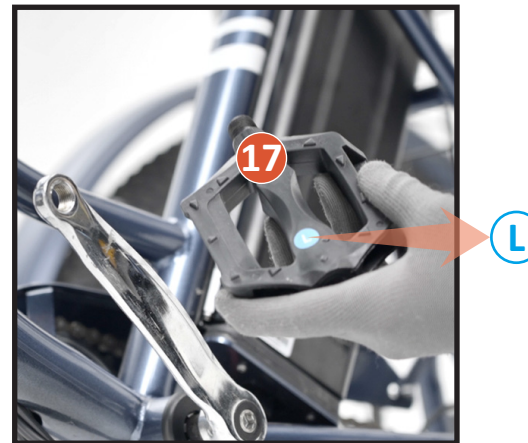

Screw the pedal labeled **L** (17) onto the crank arm at the **LEFT** side.

4



Tighten the locking nut using the same tool.



## 4.14 Installing the Rear Wheel Caps

1

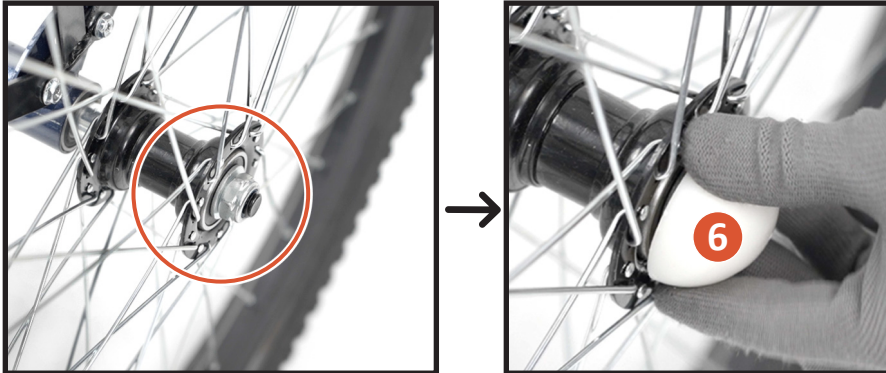

Fit the rear wheel caps (6) onto the rear wheel hubs.

2

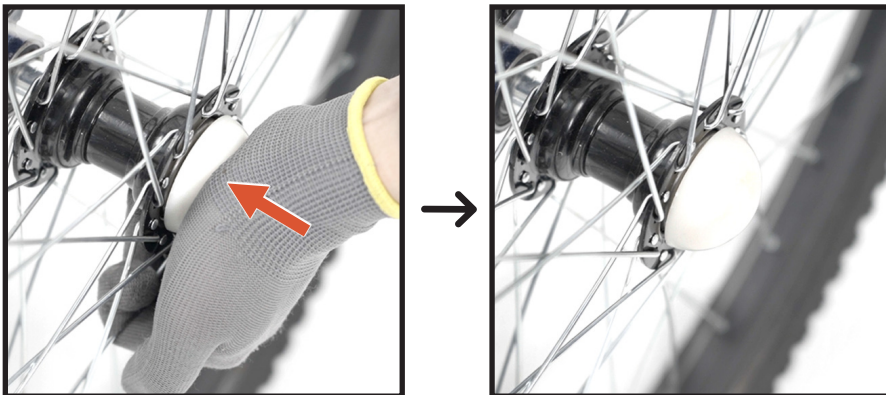

Press the caps until they click into place.

## 4.15 Installing the Front Reflector

1



Clamp

- Ensure that the clamp of the front reflector (21) is open.
- Place the reflector onto a convenient position on the handlebars (19) using its clamp.

2

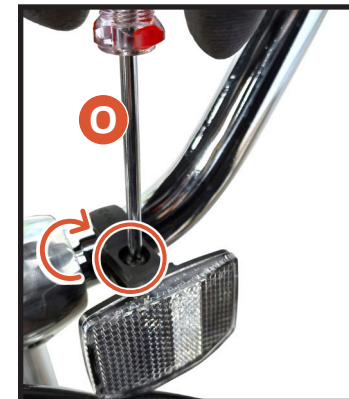

Use the dual-purpose screwdriver (O) to tighten the clamp bolt until the reflector is locked into place.

## 4.16 Connecting the Wires

### 4.16.1 Connecting the Motor Wire

1

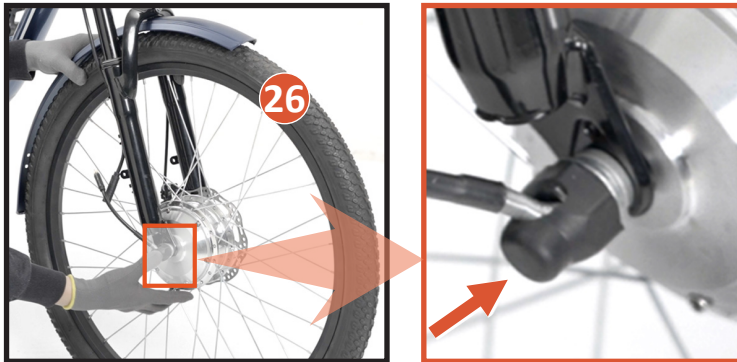

- a. Slide the protective cap onto the right side of the motorized front wheel (26).
- b. Push the cap until it becomes secure to the nut at the wheel hub.

2

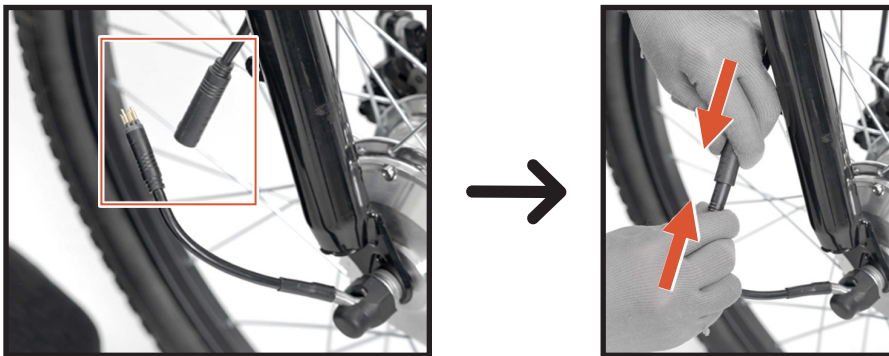

Connect the motor wire to the matching plug as shown.

### 4.16.2 Connecting the Front Light Wire

1



Locate the yellow-banded wire from the front light (23) and the identically colored plug.

2



Connect the light wire to the plug as shown.

## 4.17 Post-Assembly Actions

### Caution

*Remember to take the following post-assembly actions to ensure optimal functionality for a safe and enjoyable riding experience.*

*Failure to do so may result in unpleasant riding, property damage, and personal injury.*

- Thoroughly check that **ALL** components and fasteners **ARE** unbroken and securely attached.

Pay special attention to the frame connections, handlebars, saddle, chains, pedals, and wheels.

- Test smooth operation by rotating the wheels, steering, and pedaling.

Make sure that **ALL** movements **ARE** fluid and free from any unusual resistance.

- Inspect the front and rear brakes by pressing their levers while pushing the tricycle forward.

Be sure that **BOTH** brake levers can effectively engage the manual brake systems, facilitating prompt and responsive deceleration and bringing the tricycle to a smooth and controlled stop.

### Warning

*Even when power is cut to the motor, the tricycle's inertia often demands active braking.*

# 5. Operation

## 5.1 Charging

In addition to the handlebar display, your tricycle's current power level can be checked on the battery (14) itself.

Turn the key to **ON** and hold the power display button, seeing how many of the battery's indicator lights turn on.

3 lights indicate a full battery, while 1 light indicates a weak one.

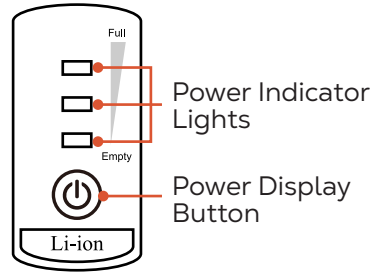

### **!** Danger

For your safety, read the battery safety instructions in **Safety Information (Page 3)** prior to operation.

### **!** Caution

- **DO NOT** allow the battery to ever drain completely, which may reduce its lifespan and even make it hard to reactivate.
- **DO NOT** leave the battery connected to power once it is already fully charged, as overcharging can cause the battery to overheat, which may result in decreased performance.

**Note:** In the event that charging fails, refer to **Troubleshooting on Page 51** for the usual solutions.

When you find that recharging is necessary:

1. Turn the key counterclockwise to **OFF**.

You can take out the battery to charge it for convenience:

- a. Push in the key, turning it counterclockwise to **UNLOCK**.
- b. Push up the locking lever, raising the rear of the saddle as shown.

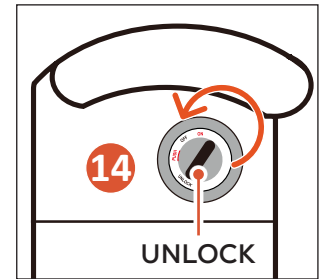

- b. Push up the locking lever, raising the rear of the saddle as shown.



- c. Hold the handle at the top of the battery, lifting the battery away from the tricycle.



2. Connect the provided charger (**M**) to its power cord (**N**) and the charging port at the opposite side of the key hole.

Connect the power cord to a stable and compatible power source.

The charger's power indicator light should turn red and charging begin.

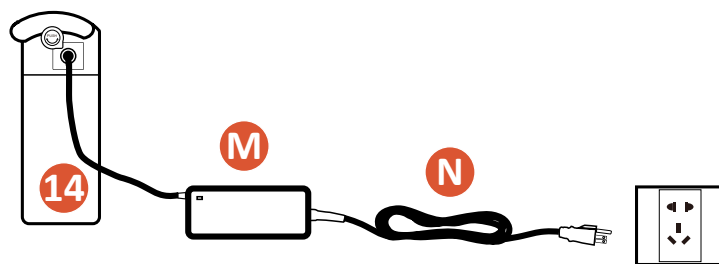

3. Periodically check the state of the battery using the power display button.

There is no need to fully recharge the battery. Either 2 or 3 lights should provide strong and responsive service.

4. When finished, disconnect the power cord from the power.

5. Properly insert the battery into the holder and then replace the saddle if you take out it.



## 5.2 Turning ON/OFF the Tricycle

To turn on the tricycle:

1. Ensure that the battery remains in place behind the saddle and has sufficient power as described in **Charging on Page 33**.
2. Unfasten the keys from the handlebars for the first use.  
Insert one key into the socket at the left side of the battery.
3. Turn the key clockwise to **ON**.
4. Locate the display panel on the left handlebar.  
Hold the  button until the panel activates.

To turn off the tricycle, hold  until the panel shuts down.



### **Warning**

**ALWAYS** turn off the tricycle between uses or before riding with manual control

### **Caution**

Simply deactivating the battery can also turn off the tricycle without deactivating the display panel in advance.

**HOWEVER**, such abrupt cut of power is **NOT** recommended and risks damaging the tricycle's circuits and controller.

## 5.3 Throttle Control

Throttle control is available when the display panel is on, enabling your tricycle to run at the 15.5 mph (25 km/h) top speed using the throttle on the right handlebar.

Turn the throttle handle and stop pedaling the tricycle. Your tricycle will continue along at the top speed.

**Note:** The tricycle will not exceed its top speed on flat pavement but may do so on slopes.

Throttle control automatically pauses and the motor temporarily shifts to neutral in the following cases:

- You release the throttle handle completely.
- You press either brake lever.
- You accelerate beyond the 15.5 mph (25 km/h) top speed.



The motor will resume working in the following conditions:

- You turn the throttle handle again.
- You release both brake levers.
- Your speed returns to the top speed or below.

If you begin pedaling while throttle control is active, the tricycle will activate pedal assist control.

If you turn off the display panel or battery while throttle control is active, the motor will stop and the tricycle will only operate manually.

### **Warning**

**DO NOT** deactivate the battery while riding. Such distraction can invite accidents.

## 5.4 Pedal Assist Control

The pedal assist system (PAS) is available when the display panel is on, requiring you to continue using the pedals to keep the motor active but providing additional speed and strength as you ride.

The PAS has 5 levels. The tricycle will accelerate to the speed of current level as soon as the pedals fully turn two times.

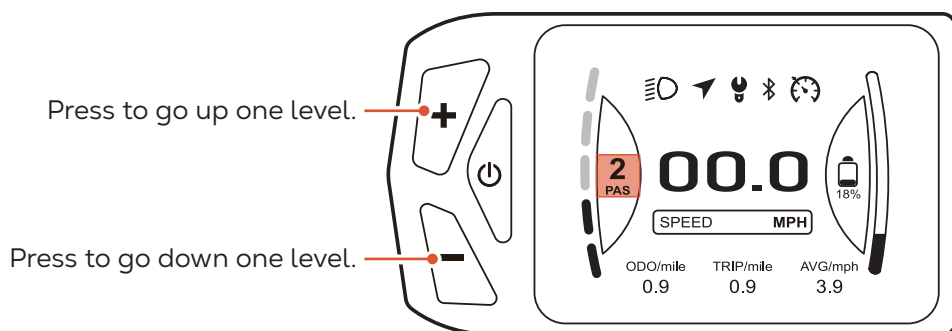

Level	0	1	2	3	4	5
Speed	–	5 mph	7.5 mph	10 mph	12.5 mph	15.5 mph
	–	8 km/h	12 km/h	16 km/h	20 km/h	25 km/h

**Note:** True speed will vary according to variables.

The PAS automatically pauses and the motor temporarily shifts to neutral in the following cases:

- You stop pedaling.
- You press either brake lever.
- You accelerate beyond the 15.5 mph (25 km/h) top speed.

The PAS reactivates in the following conditions:

- You resume pedaling.
- You release both brake levers.
- Your speed returns to the top speed or below.

If you turn the throttle while the PAS is active, the tricycle will activate throttle control and accelerate to its top speed.

If you turn off the display panel or battery while the PAS is active, the motor will stop and the tricycle will only operate manually.

Downshifting the PAS level to **0** disables the PAS and puts the motor in neutral until the + button is pressed, restarting PAS at Level 1.

### Warning

**DO NOT** deactivate the battery while riding. Such distraction can invite accidents

## 5.5 Cruise Control

Cruise control is available when the display panel is on, allowing you to ride the tricycle at a constant speed without turning the throttle or pedals.

1. Use the throttle or pedal assist control to reach your ideal speed ( $\geq 5$  mph or 8 km/h).
2. Hold the – button until  is displayed.
3. Release the throttle or stop pedaling.  
Your tricycle should maintain its current speed without further adjustment.
4. To deactivate cruise control, press either brake lever, shifting the tricycle to neutral.

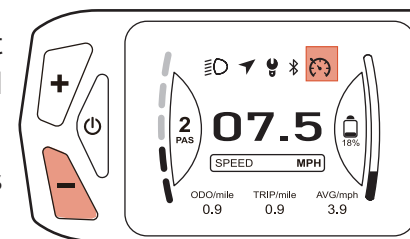

Alternatively, turn the throttle or pedals to instantly resume throttle or PAS control.

## 5.6 Push Assist Control

The push assist system is available when the display panel is on, providing additional strength as you push the tricycle for a walk or climb.

1. Stand beside the tricycle.
2. Hold the - button while pushing your tricycle forward, which will cause the motor to run at a very low speed around 2.5 mph (4 km/h).

During the process,  should be present in the PAS level display area.

3. To stop push assist control, release - or press either brake lever.

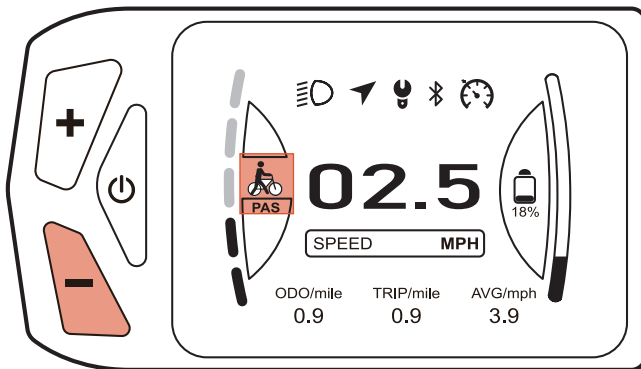

### Caution

Push assist control is **NOT** recommended in the following conditions:

- You are going down steep inclines.
- You are walking over rough terrains or obstacles.
- You are navigating through confined or crowded areas.
- You need to push the tricycle for an extended period of time.

## 5.7 Manual Control

To ride your tricycle normally, you can select any of the following methods:

- Downshift the PAS level to **0**.
- Turn off the display panel.
- Leave the key in the **OFF** position on the battery.
- Simply remove the battery from the tricycle as described in **Charging on Page 33**.

### Adjusting the Speed Gearing

The gear shifter on the right handlebar uses a button and a lever to control the 7 rear cogs, providing 7-speed gearing for manual riding.

The larger the number, the smaller the cog and the faster the tricycle will turn the wheels with the same effort.

**Note:** Be sure that your tricycle's crank is turning while using the shifter to adjust the chain on the cogs.







## 5.8 Navigation

Navigation is available when the display panel is connected to the mobile app **BIKEGO** via Bluetooth, offering precise turn-by-turn directions, real-time updates, and route optimization through GPS.

To set up the Bluetooth connection, refer to **6.20** on **Page 47**.

To turn on navigation, follow your app service provider's instructions.

When navigation is operating, both the  and  icons should light up on the digital display.

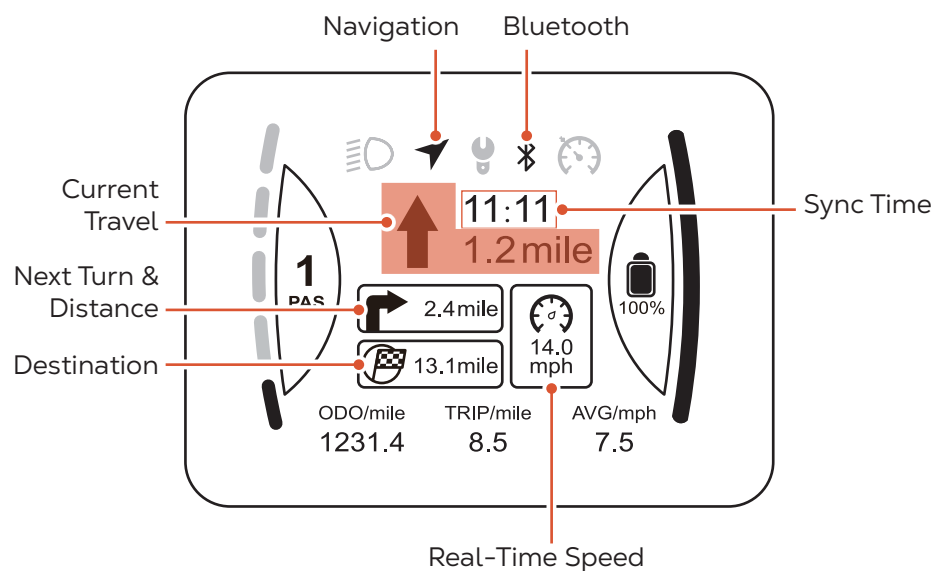



# 6. User-Defined Parameter Menus

## 6.1 General Guide

1. When the display panel is on, hold the + and - buttons simultaneously to enter the user-defined parameter menu directory (SETTING).



2. Use + or - to select a menu.

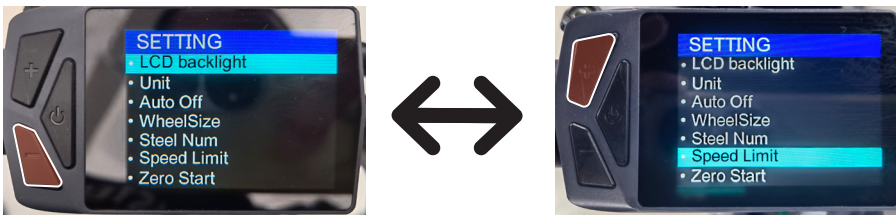

3. Press the ⏻ button to open the menu.

- In an adjustment menu, use + or - to select a desired setting.

To save your change, press ⏻ again and the directory should resume.

To cancel, wait without operation until the digital display resets by itself.



- In a display or single-selection menu, pressing ⏻ again directly resumes the directory.



4. When finished, leave the menus.

- In the directory, use + or – to select **EXIT** and then press .



- In a menu, wait without operation until the digital display automatically resets.

**Note:** Such automatic reset does not retain any changes to the settings.



 **Caution**

- NEVER** adjust the default settings in the following parameter menus randomly without professional guidance.
- These menus can be used to modify the display panel to work with other motorized wheels.
- HOWEVER**, changing any of these settings during use with this tricycle **WILL** cause it to perform abnormally, malfunction, and/or break.
- If such adjustment happens accidentally, stop the tricycle and correct the settings **IMMEDIATELY**.

Menus	Default Settings
Wheel Size	24.0 or 26.0
Steel Num	6
Boost Magnetic Type	12
Voltage Level	48V

## 6.2 Display Brightness

Open the **LCD Backlight** menu.

For best results, use the minimum setting that is clearly visible.

This prolongs your battery life a very little bit but more importantly allows your eyes to go between the road and the display with less readjustment in low light conditions.

- Setting **10%** is the dimmest.
- Setting **100%** is the brightest.



## 6.3 Measurement Units

Open the **Unit** menu.

By default, speeds and distances are displayed in imperial customary units (mph and miles).

You can toggle between this and metric units (km/h and km).

- Setting **KM** is metric.
- Setting **MILE** is imperial.

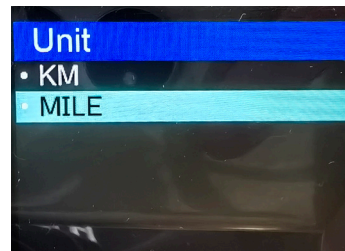

## 6.4 Timed Shutoff

Open the **Auto Off** menu.

By default, the display panel and motor will automatically shut off once your tricycle has stopped moving for 10 minutes (Setting **10**).

You can adjust the number of minutes before the display shuts down between **1** and **60**.

Decreasing this setting to **0** disables the timed shutoff, putting the panel and motor in standby mode indefinitely when you park your tricycle.

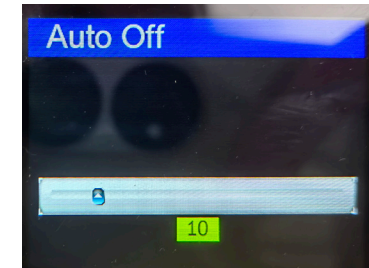

## 6.5 Wheel Diameter

Open the **Wheel Size** menu.

This modifies the system to accommodate motorized wheels with various diameters.

### Caution

**NEVER** adjust the default setting at random.

*If it is ever changed by accident, stop the tricycle and reset it depending on the wheel size (**24.0** or **26.0**) before continuing on your way.*

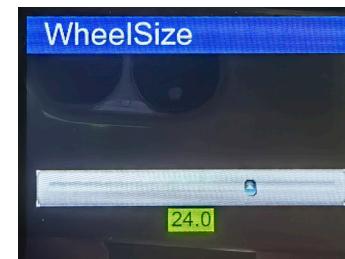

## 6.6 Speed Sensor

Open the **Steel Num** menu.

This concerns the magnet arrangement within the speed sensor.

### Caution

*NEVER adjust the default setting at random.*

*If it is ever changed by accident, stop the tricycle and reset it to **6** before continuing on your way.*

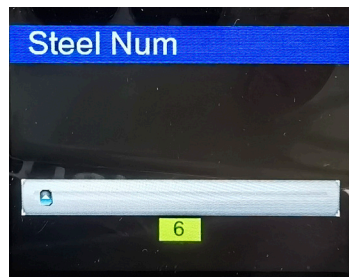

## 6.8 Throttle Start

Open the **Zero Start** menu.

By default, the throttle instantly activates the tricycle's single-speed run.

You can toggle between this and requiring two full rotations of the pedals before throttle control activates.

- Setting **On** enables instant throttle response.
- Setting **Off** enables a two-rotation start.

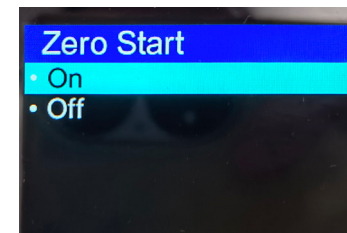

## 6.7 Top Speed

Open the **Speed Limit** menu.

By default, your motor has an overall top speed of 15.5 mph or 25 km/h (Setting **100**).

This controls the throttle speed and the true top speed of each PAS level in percentage (%).

### Warning

*NEVER ALWAYS observe the local and national laws and regulations on speed limit for electric bicycles and tricycles.*

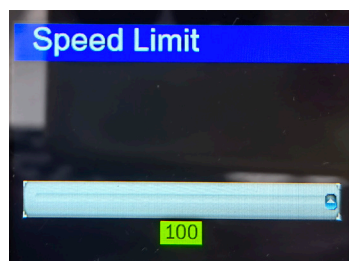

## 6.9 Disabling PAS or Throttle Control

Open the **Boost Drive** menu.

By default, your tricycle offers both PAS and throttle control.

You can toggle among this, enabling PAS only, and enabling throttle control only.

- Setting **Assistance** disables throttle control.
- Setting **Shifter** disables PAS control.
- Setting **S&A** re-enables both.

To disable both PAS and throttle control, simply turn off the display panel.

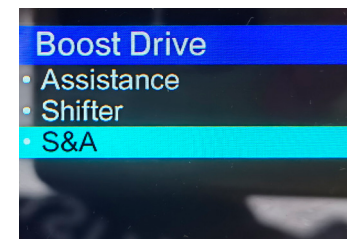

## 6.10 PAS Sensitivity

Open the **E-ABS Strength** menu.

This adjusts how quickly you need to turn the pedals to activate PAS control.

By default, the PAS activates when you turn the pedals two full rotations (**OFF**) while the display panel is on.

- Setting **Weak** requires more pedaling.
- Setting **Strong** requires less.

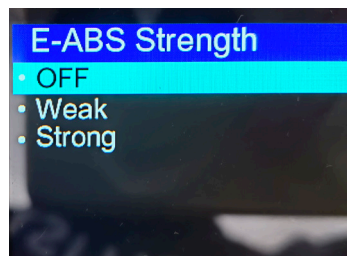

## 6.11 PAS Acceleration

Open the **Start Strength** menu.

This adjusts how quickly your tricycle ramps up the PAS speed for its current level.

Fine-tune this acceleration to suit your riding style.

Lower values accelerate more gradually and higher values more quickly.

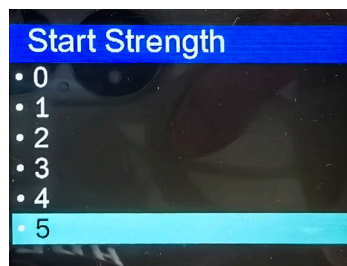

## 6.12 PAS Sensor

Open the **Boost Magnetic Type** menu.

This concerns the magnet arrangement within the PAS sensor.

### Caution

***NEVER** adjust the default setting at random.*

*If it is ever changed by accident, stop the tricycle and reset it to **12** before continuing on your way.*

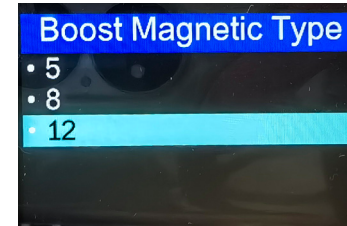

## 6.13 Resetting the Trip Odometer

Open the **Trip Reset** menu.

The total distance traveled (**ODO**) cannot be cleared.

The current trip distance (**TRIP**) and average speed (**AVG**) can be returned to **0.0**.

Hold **+** until the digital display resets, clearing the trip odometer.

Pressing exits the menu and resumes the directory.

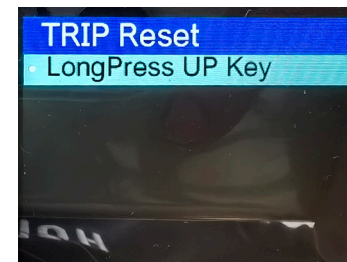

## 6.14 Fault History

Open the **Error Code** menu.

All faults that have occurred will be displayed in the form of error codes.

For details, refer to **Troubleshooting** on **Page 51**.

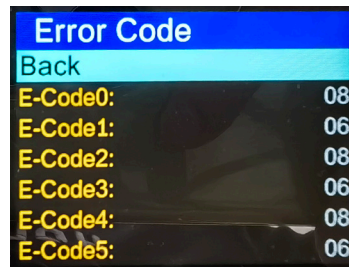

## 6.15 Bluetooth RSSI Level

Open the **BT RSSI Level** menu.

This adjusts the Bluetooth RSSI (received signal strength indicator), concerning the signal strength of the Bluetooth connection between the tricycle and a mobile device, such as a smartphone operating a bike control app.

Setting **1** requires the closest positioning of your mobile device.

Setting **5** allows for the most remote distance.

Nonetheless, any of these settings will enable the Bluetooth connection as long as your mobile device is carried with you during a ride.



## 6.16 Battery Voltage

Open the **Voltage Level** menu.

This modifies the system to accommodate batteries with various output voltages.

### **Caution**

***NEVER** adjust the default setting at random.*

*If it is ever changed by accident, stop the tricycle and reset it to **48V** before continuing on your way.*

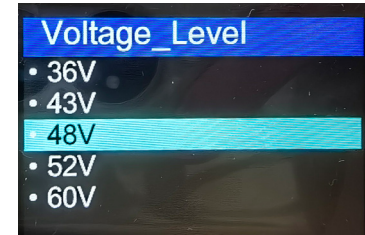

## 6.17 Disabling Cruise Control

Open the **Cruise** menu.

By default, your tricycle offers cruise control.

- To disable this, select **Off**.
- To re-enable this, select **On**.

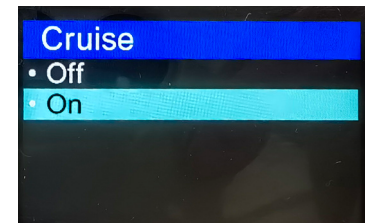

## 6.18 Menu Languages

Open the **Language** menu.

By default, **English** is the menu language.

- For Español, select **Spanish**.
- For Simplified Chinese, select **简体中文**.

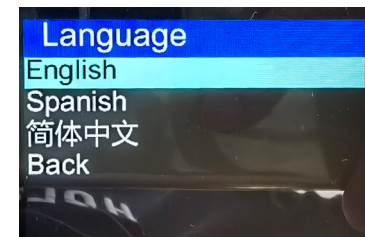

Selecting **Back** retains the current language and returns to the directory.



## 6.19 Password Protection

Open the **Password** menu.

By default, password protection is deactivated (**Off**).

Pressing **Back** exits the menu and returns to the directory.

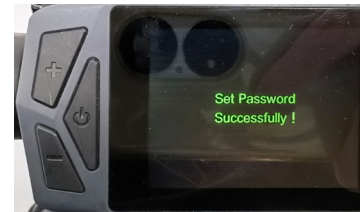
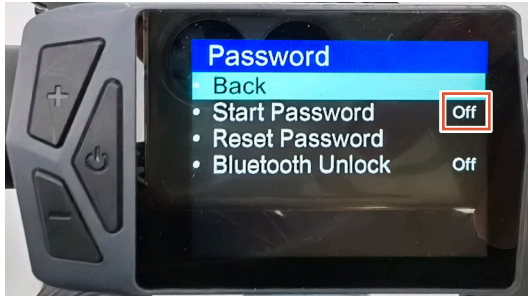

### 6.19.1 Activating Password Protection

1. Use + or - to select **Start Password**.
2. Press to access the **Password Set** interface.
3. Use + or - to enter a number for the first digit.
4. Press to confirm the first digit and move on to the next one.
5. Repeat **steps 3-4** for the remaining digits.

Once the last digit is confirmed, password protection should activate (**On**).

**Note:** The system applies **0000** as the default password.

Next time you hold to turn on the display panel, simply enter the password and then the display should activate.







### 6.19.2 Resetting the Password

1. Use + or – to select **Reset Password**.
2. Press  to access **Password Set**.
3. Follow **steps 3–5** in **16.19.1** on **Page 45** to enter your old password and move on to the new password setting interface.
4. Enter and confirm your new password in the same fashion.

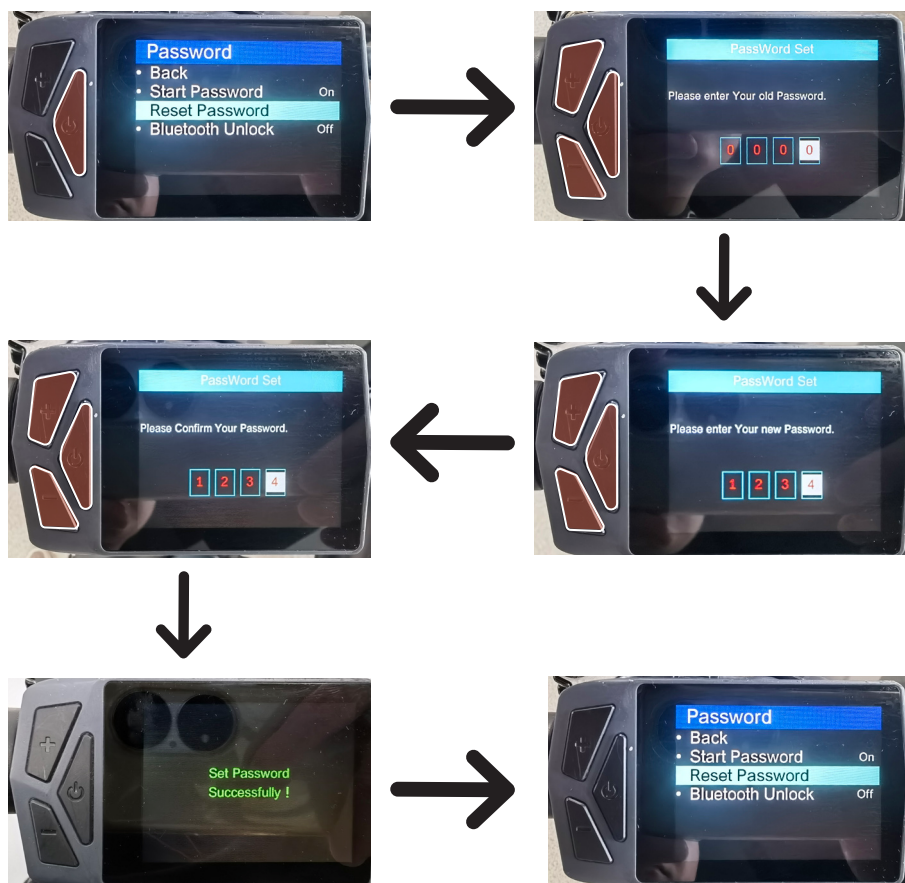
When finished, the new password is available and the **Password** menu display resumes.



### 6.19.3 Deactivating Password Protection

1. Use + or – to select **Start Password**.
  2. Press  to access the **Password Set** interface.
  3. Enter and confirm your password as described on **Page 45**.
- When finished, password protection should deactivate (**Off**).

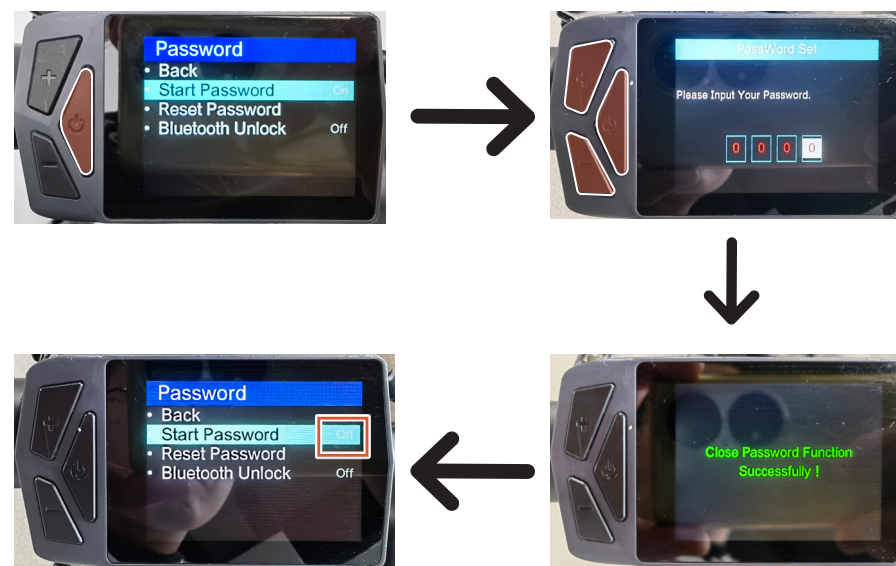



## 6.20 Bluetooth Connection

### 6.20.1 Unlocking Bluetooth

1. Open the **Password** menu.
2. Select **Bluetooth Unlock**.

By default, Bluetooth is locked (**Off**).

3. Select **On** to unlock Bluetooth.

The digital display will jump to the **Bluetooth** menu.

4. If you have ever connected your mobile device to the tricycle via Bluetooth, press  to return to the directory or wait without operation until the digital display resets.

Otherwise, follow **6.20.2** to establish the connection to your mobile device.

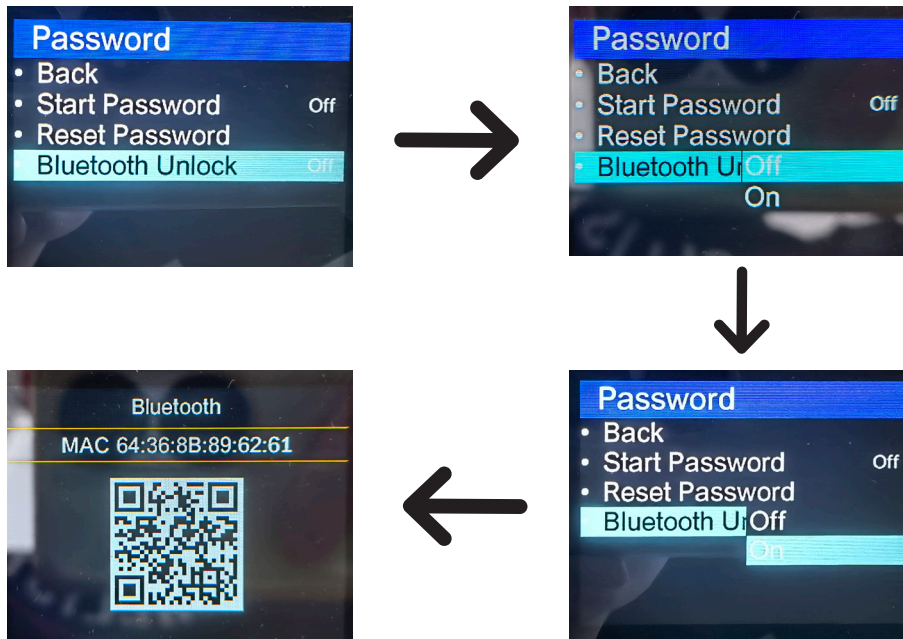

### 6.20.2 Establishing the Connection

**Note:** Ensure that Bluetooth is already activated on your mobile device.

1. Open the **Bluetooth** menu in the directory or following **6.20.1**.
2. Scan the displayed QR code using the **BIKEGO** app on your mobile device.
3. Establish the Bluetooth connection using your app.

Follow the app service provider's instructions.

You may be required to log into a valid account before operating anything.

4. When finished, wait until the digital display automatically resets.

The  icon should light up.



## 6.21 System Version

Open the **Display Info** menu.

**SW** refers to the software version number.

**HW** refers to the hardware version number.

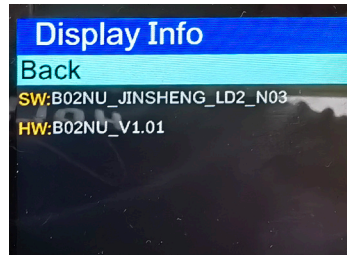

## 6.22 Restoring the Factory Settings

**Note:** This applies to the display brightness, Bluetooth RSSI level, menu languages, and password protection **ONLY**.

1. Open the **Reset** menu.
2. Select **Confirm** to begin resetting the system.
3. When restoration is complete, enter the default password (**0000**) following 6.19.1 on Page 45 to activate the display panel.



# 7. Technician-Defined Issues

## 7.1 Parameter Menus

1. In the **SETTING** directory, hold the - button to enter the **Factory Mode** directory.

Here come the **Version, Keypad, Backlight, LCD TEST, Bluetooth, USB Charger, USB LOG, and Demo Show** menus.

2. Use the + or - button to select a menu.
3. Press the button to open the menu.
4. To exit, hold + until the digital display resets.

### Caution

- These menus were designed **ONLY** for professional servicing by trained technicians.
- **NEVER** attempt to operate these menus **WITHOUT** prior training or professional guidance.



## 7.2 Quick Test

In the **SETTING** directory, hold + to activate **Quick Test**, performing a quick diagnostic test of the tricycle's electronic components and sensors before troubleshooting any potential issues.

- To start a test, press +.
- To retest, press .
- To view the historical reports, press -.
- To exit, hold - until the digital display resets.

### Caution

*If errors are reported during a quick test conducted by yourself, ask trained technicians to perform a retest and resolve the problems before further use.*

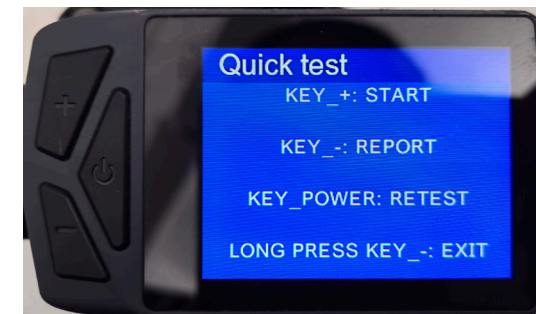

## 8. Maintenance

### Warning

***DO NOT** leave the display panel or battery on during cleaning, maintenance, or repair. Failure to follow this may result in accidental activation of the motor, posing a series of safety hazards.*

- For the longest possible service life, disconnect the battery from the tricycle between uses.
- Check the parts of the tricycle for any looseness, stiffness, wear, or damage after each use. Tighten, lubricate, repair, or replace any problematic parts before further use.

### Warning

***ONLY** use identical replacements.*

- Clean the exterior of the tricycle with a soft dry or damp cloth.

### Caution

- **DO NOT** use harsh abrasives or caustic chemicals.
- All electronic components have waterproofing adequate for rain.

***HOWEVER**, avoid direct pressurized spray that might allow the interior of electronic components to become wet, **NEVER** charge the battery while it or your hands are wet, and **IMMEDIATELY** replace the battery if it ever begins to swell or leak fluid.*

- If the tricycle is not to be used for an extended period, remove the battery and store everything in a cool dry place inaccessible to children and away from direct sunlight and rain.

Avoid storing electronics in plastic bags, which might allow humidity to build up over time.

For best results, check the battery every three months. If its power sinks below  $\frac{2}{3}$  (2 of the 3 indicator lights), recharge it to at least that full before returning it to storage.



# 9. Troubleshooting

## 9.1 Error Codes

Codes	Implications	Solutions
04	Throttle Mispositioned	Push the throttle forward into place.
05	Throttle Fault	Seek professional assistance from trained technicians.
06	Undervoltage Lockout	
07	Overvoltage Lockout	
08	Hall Effect Sensor Fault	
09	Motor Phase Fault	
11	Temperature Sensor Fault	
12	Current Sensor Fault	
13	Battery Overheated	
14	Motor Overheated	
21	Speed Sensor Fault	
22	BMS Fault	Ask your local dealer or contractor for a new identical battery.
30	Communication Fault	Seek professional assistance from trained technicians.

## 9.2 Other Issues

Problems	Solutions
Charging fails.	Ensure the charger is firmly connected to the battery's charging port and a working power source.
	Revive the battery in an over-low-power state. <ol style="list-style-type: none"> <li>1. Reinstall the battery onto your tricycle.</li> <li>2. Raise the motorized front wheel.</li> <li>3. Run the motor using the throttle for a while.</li> <li>4. Stop the motor, disconnect the battery, and restart charging.</li> </ol>
The throttle, PAS, push assist, or cruise control does not work.	Replace the charger, power cord, or battery with a new identical one.
	Ensure the battery is seated in place with the key in its <b>ON</b> position.
	Ensure the display panel is already on. Ensure such control is not disabled.
The password is forgotten.	If no new password is already set, simply enter the default <b>0000</b> .
	Contact customer service or your local dealer or contractor for professional assistance.
Bluetooth connection or navigation fails.	Ensure Bluetooth is unlocked on the display panel and active on your mobile device.
	Make sure the app you are using is <b>BIKEGO</b> .
	Be sure to log into a valid <b>BIKEGO</b> account. Select higher settings in the <b>BT RSSI Level</b> menu.

Problems	Solutions	
The chain cannot be exactly positioned on the smallest cog at the highest gear (7).	Adjust the high-limit screw (H) with the dual-purpose screwdriver until the guide pulley and the smallest cog are lined up.	 <p data-bbox="864 675 1056 703">Rear Deraillieur</p>
The chain cannot be exactly positioned on the largest cog at the lowest gear (1).	Adjust the low-limit screw (L) with the dual-purpose screwdriver until the guide pulley and the largest cog are lined up.	

## Disposal

Electrical products should not be disposed of with household products. In the EU and UK, according to the European Directive 2012/19/EU for the disposal of electrical and electronic equipment and its implementation in national laws, used electrical products must be collected separately and disposed of at the collection points provided for this purpose. Locations in Australia, Canada, and the United States may have similar regulations. Contact your local authorities or dealer for disposal and recycling advice.

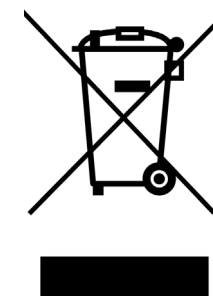

A B E - S 1 A B - A B

A B E - S 1 A B - A G

A B E - S 1 A B - A K

A B E - S 1 A B - A R

A B E - S 2 A B - A B

A B E - S 2 A B - A G

A B E - S 2 A B - A K

A B E - S 2 A B - A R

Rev. 30 Sept. 2024